



Built-in oven HBA36B6.0W



BOSCH

[en] Instruction manual

Safety precautions	4	Energy and environment tips	19
Before installation	4	Saving energy.....	19
Safety notes	4	Environmentally-friendly disposal.....	19
Causes of damage.....	4	Automatic programmes	19
Your new oven	5	Ovenware	19
Control panel	5	Preparing the dish	19
Buttons.....	5	Programmes	20
Rotary selector	5	Selecting and setting a programme	22
Display	5	Tips for the automatic programmes.....	23
Temperature indicator.....	5	Tested for you in our cooking studio	23
Cooking compartment.....	6	Cakes and pastries	23
Accessories	6	Baking tips	25
Before using the appliance for the first time	8	Meat, poultry, fish	26
Setting the clock	8	Tips for roasting and grilling.....	28
Heating up the cooking compartment.....	8	Slow cooking	28
Cleaning the accessories.....	8	Tips for slow cooking.....	29
Switching the oven on and off	8	Bakes, gratins, toast with toppings	29
Switching on	8	Convenience products.....	30
Switching off.....	8	Special dishes.....	30
Setting the oven	9	Defrost	31
Types of heating.....	9	Drying.....	31
Setting the type of heating and temperature.....	9	Preserving	31
Setting rapid heating	10	Acrylamide in foodstuffs	32
Time-setting options	10	Test dishes	32
Setting the time-setting options - in brief.....	10	Baking.....	32
Setting the timer	10	Grilling.....	33
Setting the cooking time.....	10		
Setting a later end time	11		
Setting the clock	11		
Memory	12		
Saving settings in the memory.....	12		
Starting the memory.....	12		
Sabbath mode	12		
Starting Sabbath mode.....	12		
Childproof lock	12		
Basic settings	13		
Changing the basic settings	13		
Automatic switch-off	14		
Cleaning system	14		
Before cleaning	14		
Setting the cleaning level	14		
After cleaning.....	14		
Care and cleaning	15		
Cleaning agents	15		
Detaching and refitting the rails.....	15		
Folding down the grill element.....	16		
Detaching and attaching the oven door.....	16		
Removing and installing the door panels	16		
Troubleshooting	17		
Malfunction table.....	17		
Replacing the bulb in the oven ceiling light	18		
Replacing the bulb in the left-hand oven light.....	18		
Glass cover	18		
After-sales service	19		
E number and FD number	19		

Additional information on products, accessories, replacement parts and services can be found at www.bosch-home.com and in the online shop www.bosch-eshop.com

⚠ Safety precautions

Please read this instruction manual carefully. Please keep the instruction and installation manuals in a safe place. Please pass on these manuals to the new owner if you sell the appliance.

Before installation

Damage during transport

Check the appliance for damage after unpacking it. Do not connect the appliance if it has been damaged in transit.

Electrical connection

Only a licensed expert may connect the appliance. You will lose your warranty entitlement in the event of any damage caused by incorrect connection.

Safety notes

This appliance is intended for domestic use only. This appliance must only be used for food preparation.

Adults and children must not operate the appliance without supervision,

- if they are physically or mentally incapable of doing so or
- if they have insufficient knowledge or experience.

Never let children play with the appliance.

Hot cooking compartment

Risk of burns!

- Never touch the interior surfaces of the cooking compartment or the heating elements. Open the appliance door carefully. Hot steam may escape. Small children must be kept at a safe distance from the appliance.
- Never prepare food containing large quantities of drinks with a high alcohol content. Alcoholic vapours can catch fire in the cooking compartment. Only use small quantities of drinks with a high alcohol content and open the appliance door carefully.

Risk of fire!

- Never store combustible items in the cooking compartment. Never open the appliance door if there is smoke inside. Switch off the appliance. Pull out the mains plug or switch off the circuit breaker in the fuse box.
- Do not place greaseproof paper loosely over accessories during preheating. A draught is created when the appliance door is opened. The greaseproof paper may come into contact with the heating element and catch fire. Always weight down the greaseproof paper with a dish or a baking tin. Only cover the surface required with greaseproof paper. The greaseproof paper must not protrude over the accessories.

Risk of short circuit!

Never trap connecting cables of electrical appliances in the hot appliance door. The cable insulation could melt.

Risk of scalding!

Never pour water into the hot cooking compartment. This will produce hot steam.

Hot accessories and ovenware

Risk of burns!

Never remove ovenware or accessories from the cooking compartment without an oven cloth or oven gloves.

Improper repairs

Risk of electric shock!

Improper repairs are dangerous. Repairs may only be carried out by one of our trained after-sales engineers. If the appliance is defective, pull out the mains plug or switch off the appliance at the circuit breaker in the fuse box. Call the after-sales service.

Causes of damage

Caution!

- Accessories, foil, greaseproof paper or ovenware on the cooking compartment floor: do not place accessories on the cooking compartment floor. Do not cover the cooking compartment floor with any sort of foil or greaseproof paper. Do not place ovenware on the cooking compartment floor if a temperature of over 50 °C has been set. This will cause heat to accumulate. The baking and roasting times will no longer be correct and the enamel will be damaged.
- Water in a hot cooking compartment: do not pour water into the cooking compartment when it is hot. This will cause steam. The temperature change can cause damage to the enamel.
- Moist food: do not store moist food in the cooking compartment when it is closed for prolonged periods This will damage the enamel.
- Fruit juice: when baking particularly juicy fruit pies, do not pack the baking tray too generously. Fruit juice dripping from the baking tray leaves stains that cannot be removed. If possible, use the deeper universal pan.
- Cooling with the appliance door open: only allow the cooking compartment to cool when it is closed. Even if the appliance door is only open a little, front panels of adjacent units could be damaged over time.
- Heavily soiled oven seal: if the oven seal is heavily soiled, the oven door will no longer close properly when the oven is in operation. The fronts of adjacent units could be damaged. Always keep the oven seal clean.
- Oven door as a bearing surface: do not stand or place objects on the oven door when it is open. Do not place ovenware or accessories on the oven door.
- Carrying the appliance: do not carry or hold the appliance by the door handle. The door handle cannot support the weight of the appliance and could break.

Your new oven

Here you will learn about your new oven. The control panel and the individual operating controls are explained. You will find information on the cooking compartment and the accessories.

Control panel

Here, you will see an overview of the control panel. Depending on the appliance model, individual details may differ.

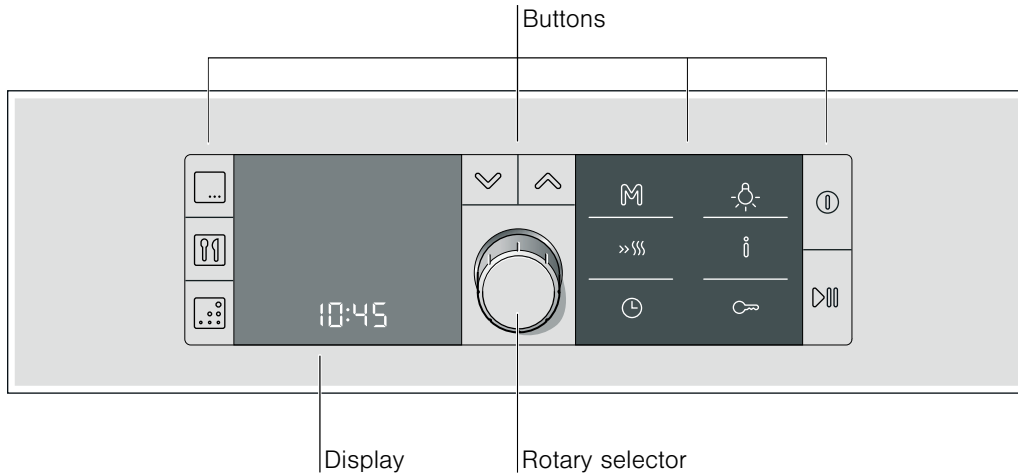

Buttons

The sensors are located under the individual buttons. They must not be pressed too firmly. Just touch the corresponding symbol.

Symbol	Button function
	Selects the type of heating and temperature
	Selects automatic programmes
	Selects the cleaning system. This button is not assigned. The cleaning system can only be selected when the self-cleaning ceiling and side parts have been retrofitted and connected, and the cleaning system has been activated in the basic settings.
	Moves one row down
	Moves one row up
	Press and hold = selects the memory Press briefly = starts the memory
	Setting rapid heating
	Opens and closes the time-setting options
	Switches the oven light on and off
	Press briefly = calls up the temperature Press and hold = opens and closes the Basic settings menu
	Activates/deactivates the childproof lock
	Switches the oven on and off
	Press briefly = starts/pauses operation Press and hold = cancels operation

Rotary selector

The rotary selector is used to alter the default values and set values. The brackets in the control panel show which value you can adjust.

The rotary selector is retractable. Press on the rotary selector to pop it in or out.

Display

The display is divided into different areas.

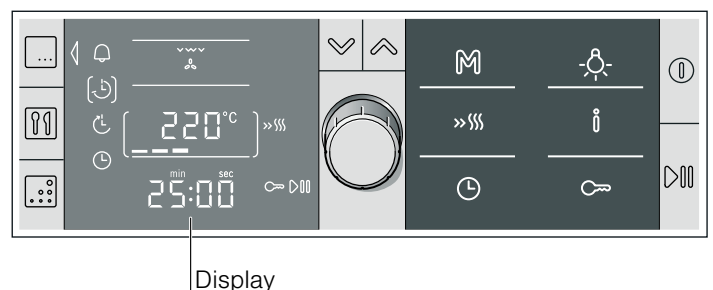

- Left area = time-setting options
When you open the Time-setting options menu, the symbols for the time-setting options are displayed here. An outside ◀ arrow on the left points to the operating mode which has been selected.
- Centre area = settings area
1st row = type of heating display
2nd row = temperature display
3rd row = clock display
You can use the and navigation buttons to switch from one row to the other. Brackets are displayed around the row you are currently in. You can use the rotary selector to change the value in brackets.
- Right area = display
Symbols for the various functions are displayed here, e.g. for the childproof lock or rapid heating, etc. if they have been set.

Temperature indicator

The temperature indicator bars show the heating phases or residual heat in the cooking compartment.

Heating indicator

The heating indicator displays the rising temperature in the cooking compartment. If all bars are filled, the optimum time for placing the dish in the oven has been reached.

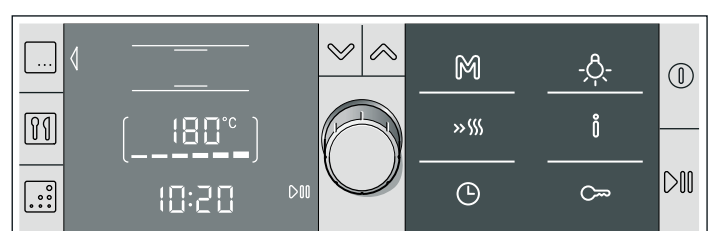

The bars do not appear when settings are made for grilling and cleaning.

You can use the **i** button to check the current heating temperature while the oven is heating up. Due to thermal inertia, the temperature displayed may differ slightly from the actual temperature in the cooking compartment.

Residual heat

The temperature indicator shows the residual heat in the cooking compartment when the appliance is switched off. If all the bars are filled, the temperature in the cooking compartment is approximately 300 °C. Once the temperature has dropped to approximately 60 °C, the display goes out.

Cooking compartment

The oven light is located in the cooking compartment. A cooling fan protects the oven from overheating.

Oven light

During operation, the oven light in the cooking compartment is on. When temperatures up to 60 °C are selected, the light remains switched off. This enables precise temperature regulation.

The oven light switches on when you open the oven door.

You can use the  button to switch the light on and off.

Cooling fan

The cooling fan switches on and off as required. The hot air escapes above the door. Caution: do not cover the ventilation slots. Otherwise the oven will overheat.

So that the cooking compartment cools down more quickly after operation, the cooling fan continues to run for a certain period afterwards.

Accessories

The accessories can be inserted into the oven at 5 different levels.

You can pull out the accessories two thirds of the way without them tipping. This allows dishes to be removed easily.

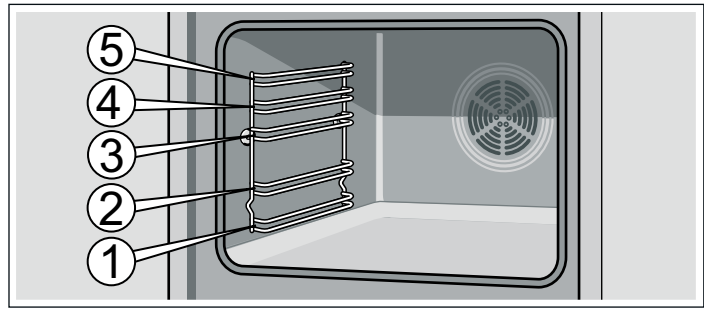

The accessories can become deformed when they get hot. As soon as they have cooled down, the deformation disappears with no effect on the function.

You can buy accessories from the after-sales service, from specialist retailers or online. Please specify the HEZ number.



Wire rack

For ovenware, cake tins, joints, grilled items and frozen meals.

Insert the wire rack with the curvature pointing downward .



Enamel baking tray

For cakes and biscuits.

Push the baking tray into the oven with the sloping edge facing towards the oven door.

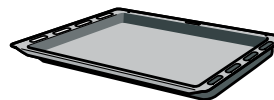

Universal pan

For moist cakes, pastries, frozen meals and large joints. It can also be used to catch dripping fat when grilling directly on the wire rack.

Slide the universal pan into the oven with the sloping edge facing the oven door.

Special accessories

You can purchase special accessories from the after-sales service or specialist retailers. You will find a comprehensive range of products for your oven in our brochures and on the Internet. The availability of special accessories and whether it is possible to order them online may vary depending on your country. Please see the sales brochures for more details.

Not all optional accessories are suitable for every appliance. When purchasing, please always quote the exact identification number (E no.) for your appliance.

Special accessories	HEZ number	Use
Wire rack	HEZ334000	For ovenware, cake tins, joints, grilled items and frozen meals.
Enamel baking tray	HEZ331000	For cakes and biscuits. Push the baking tray into the oven with the sloping edge facing towards the oven door.
Universal pan	HEZ332000	For moist cakes, pastries, frozen meals and large joints. It can also be used to catch dripping fat when grilling directly on the wire rack. Slide the universal pan into the oven with the sloping edge facing the oven door.
Roasting rack	HEZ324000	For roasting. Always place the roasting rack in the universal pan. This ensures that dripping fat and meat juices are collected.
Grill tray	HEZ325000	Use for grilling instead of the wire rack or as a splatter guard, so that the oven does not become very dirty. Only use the grill tray in the universal pan. Grilling on the grill tray: only use at shelf height 1, 2 and 3. Using the grill tray as a splash guard: insert the universal pan with the grill tray under the wire rack.
Glass pan	HEZ336000	A deep baking tray made of glass. Can also be used as a serving dish.

Special accessories	HEZ number	Use
Pizza tray	HEZ317000	Ideal for pizza, frozen products or large round cakes. You can use the pizza tray instead of the universal pan. Place the baking tray on the wire rack and proceed according to the details in the tables.
Bakestone	HEZ327000	The bakestone is perfect for preparing home-made bread, bread rolls and pizzas which need to have a crispy base. The bakestone must always be preheated to the recommended temperature.
Enamel baking tray with non-stick coating	HEZ331010	Cakes and biscuits can be removed more easily from the baking tray. Push the baking tray into the oven with the sloping edge facing towards the oven door.
Universal pan with non-stick coating	HEZ332010	Moist cakes, pastries, frozen meals and large roasts can be removed more easily from the universal pan. Slide the universal pan into the oven with the sloping edge facing the oven door.
Profi extra-deep pan with roasting rack	HEZ333000	Ideally suited for preparing large amounts.
Lid for the Profi extra-deep pan	HEZ333001	The lid converts the Profi extra-deep pan into the Profi roasting dish.
Glass roasting dish	HEZ915001	The glass roasting dish is suitable for pot roasts and bakes that are cooked in the oven. It is ideally suited to automatic programmes or automatic roasting.
Metal roasting dish	HEZ6000	The roasting dish is intended for use on the extended cooking zone of the glass ceramic hob. It is suitable for the sensor cooking system as well as for automatic programmes or automatic roasting. The roasting dish is enamel on the outside with a non-stick coating on the inside.
Telescopic shelf x2	HEZ338250	The pull-out rails at levels 2 and 3 allow you to pull accessories out further without them tipping.
Telescopic shelf x3	HEZ338352	The pull-out rails at levels 1, 2 and 3 allow you to pull accessories out further without them tipping.
Telescopic shelf with full extension x3	HEZ338356	The pull-out rails at levels 1, 2 and 3 allow you to pull accessories out fully without them tipping.
Self-cleaning side walls		
Appliance with one oven light	HEZ339020	You can retrofit side walls so that the cooking compartment automatically cleans itself during operation.
Appliances with one oven light and automatic roasting	HEZ339020	You can retrofit side walls so that the cooking compartment automatically cleans itself during operation.
Self-cleaning oven ceiling and side walls		
Appliances with one oven light and a folding grill element	HEZ329020	You can retrofit the ceiling and side walls so that the cooking compartment automatically cleans itself during operation.
Appliances with two oven lights and a folding grill element	HEZ329022	You can retrofit the ceiling and side walls so that the cooking compartment automatically cleans itself during operation.
Appliances with one oven light, a folding grill element and a meat thermometer	HEZ329027	You can retrofit the ceiling and side walls so that the cooking compartment automatically cleans itself during operation.
Steam filter	HEZ329000	You can retrofit this in your oven. The steam filter filters out grease particles from the exhaust air, thereby reducing odours. Only for appliances with a 6, 7 or 8 as the second digit in the E No. (e.g. HBA3 <u>8</u> B750)
System steamer	HEZ24D300	For easy preparation of vegetables and fish.
After-sales service products		service, specialist retailers or (in some countries) online via the e-Shop. Please specify the relevant product number.
You can obtain suitable care and cleaning agents and other accessories for your domestic appliances from the after-sales		
Cleaning cloths for stainless-steel surfaces	Product no. 311134	Reduces the build-up of dirt. Impregnated with a special oil for perfect maintenance of your appliance's stainless-steel surfaces.
Oven and grill cleaning gel	Product no. 463582	For cleaning the cooking compartment. The gel is odourless.
Microfibre cloth with honeycomb structure	Product no. 460770	Especially suitable for cleaning delicate surfaces, such as glass, glass ceramic, stainless steel or aluminium. The microfibre cloth removes liquid and grease deposits in one go.
Door lock	Product no. 612594	To prevent children from opening the oven door. The locks on different types of appliance door are screwed in differently. See the information sheet supplied with the door lock.

Before using the appliance for the first time

This section tells you everything you need to do before using the appliance for the first time.

- Set the clock
- Heat up the cooking compartment
- Clean the accessories
- Read the safety information at the start of the instructions for use. This is very important.

Setting the clock

Once your new appliance has been connected, the ⌚ symbol and 00:00 appear in the display. Set the clock and then the oven is ready to use.

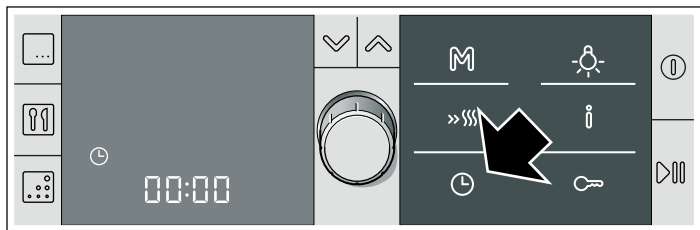

1. Press the ⌚ button.
The [⌚] symbol for the clock is shown in brackets and [12:00] appears.

2. Turn the rotary selector to set the current time.

3. Press the ⌚ button.

The current time is saved.

Note. You can read how to change the time in the *Time-setting options* section.

Heating up the cooking compartment

To get rid of the new cooker smell, heat up the cooking compartment when it is empty and the oven door closed. Set  Top/bottom heating and 240 °C.

Make sure that the cooking compartment contains no leftover packaging, e.g. polystyrene pellets.

1. Press the ⏻ button.

The  3D hot air heating type and a temperature of 160 °C are suggested. Brackets are shown around the type of heating.

2. Turn the rotary selector to change the type of heating to .

3. Press the ✓ button to switch to the temperature.
Brackets are shown around the temperature.

4. Using the rotary selector, change the temperature to 240 °C.

5. Press the ▶▶▶ button.

Appliance operation begins. The ▶▶▶ symbol lights up in the display.

6. Switch the oven off after 60 minutes using the ⏻ button.

The temperature indicator bars show the residual heat in the cooking compartment.

Cleaning the accessories

Before you use the accessories for the first time, clean them thoroughly with hot soapy water and a soft dish cloth.

Switching the oven on and off

You can switch the oven on and off with the ⏻ button.

Switching on

Press the ⏻ button.

The  symbol for the 3D hot air heating type and 160 °C are suggested in the display.

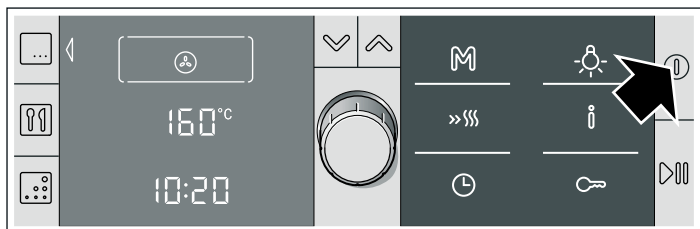

You can start the oven immediately with this setting or

- set a different type of heating or temperature
- select a programme with the M button
- select the cleaning system with the  button
- start a saved memory setting with the M button

You can read how to make these settings in the various sections.

Switching off

Press the ⏻ button. The oven switches off.











Setting the oven

In this section, you will find information about

- which types of heating are available in your oven
- how you set a type of heating and a temperature
- and how you set rapid heating

Types of heating



A large number of types of heating are available in your oven. This allows you to select the ideal way of preparing every dish.

Type of heating and temperature range	Application
 3D hot air 30-275 °C	For cakes and pastries on one to three levels. The fan distributes the heat of the ring heating element in the rear wall evenly throughout the cooking compartment.
 Top/bottom heating 30-300 °C	For cakes, bakes and lean joints of meat (e.g. beef or game) on one level. Heat is emitted evenly from the top and bottom.
 HydroBaking* 30-300 °C	For yeast-risen dough, e.g. bread, rolls or plaited loaves, and for choux pastry, e.g. cream puffs, or sponge. Heat is emitted evenly from the top and bottom. The moisture from the food remains in the cooking compartment as steam.
 Pizza setting 30-275 °C	For the quick preparation of frozen products without preheating, e.g. pizza, chips or strudel. Heat is emitted from below and by the heating ring in the back panel.
 Bottom heating 30-300 °C	For preserving, browning and the final baking stage. The heat is emitted from below.
 Hot air grilling 30-300 °C	For roasting meat, poultry and whole fish. The grill element and the fan switch on and off alternately. The fan causes the hot air to circulate around the dish.
 Grill, large area Grill settings 1, 2 or 3	For grilling steaks, sausages, toast and pieces of fish. The whole area below the grill heating element becomes hot.
 Grill, small area Grill settings 1, 2 or 3	For grilling small quantities of steaks, sausages, toast and pieces of fish. The centre part of the grill element becomes hot.
 Defrost 30-60 °C	For defrosting, e.g. meat, poultry, bread and cakes. The fan causes the warm air to circulate around the dish.
 Keep warm 60-100 °C	For keeping cooked dishes warm.

* Type of heating used to determine the energy efficiency class in accordance with EN50304.

Setting the type of heating and temperature

Example in the picture: Setting for  Top/bottom heating at 180 °C.

Switch on the oven with the  button or press the  button. The  symbol for 3D hot air and 160 °C are suggested in the display.

You can apply this setting immediately with the  button.

If you wish to specify another type of heating and temperature, proceed as follows.

1. Turn the rotary selector to set the desired type of heating.

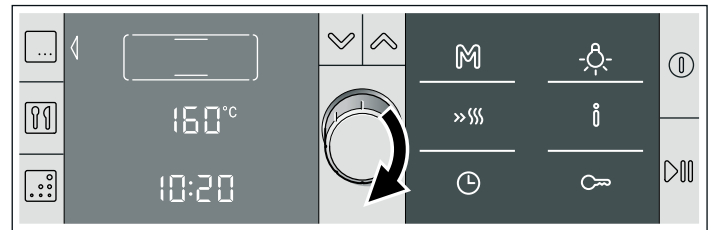

2. Press the  button to switch to the temperature.

Brackets are shown around the temperature or grill setting.

3. Modify the suggested temperature using the rotary selector.

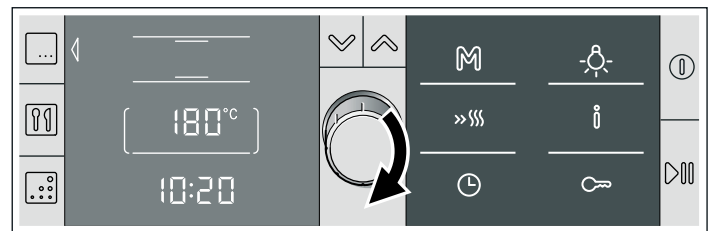

4. Press the  button.

Appliance operation begins. The  symbol lights up in the display.

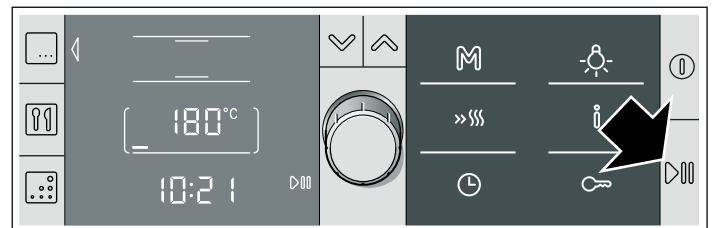

5. Once the dish is ready, switch the oven off with the  button or select and apply a new operating mode.

Changing the temperature or grill setting

This can be done at any time. Turn the rotary selector to change the temperature or grill setting.



Calling up the heating temperature

Press the  button briefly. The current heating temperature in the cooking compartment is displayed for several seconds.

Opening the oven door during cooking

Operation is suspended. The symbol  flashes. When the door is closed again, operation resumes.

Pausing operation

Press the  button briefly. The oven is paused. The  symbol flashes. Press the  button again, operation continues.

Cancelling operation

Press and hold the  button until 3D hot air and 160 °C appear. You can now change the settings.

Setting the cooking time

See section *Time-setting options*, setting the cooking time.





Setting a later end time

See the section entitled *Time-setting options*, Setting a later end time.

Setting rapid heating

Rapid heating is not suitable for all types of heating.

Suitable types of heating

-  3D hot air
-  Top/bottom heating
-  HydroBaking
-  Pizza setting

A short signal sounds to indicate that the selected type of heating is not suitable for rapid heating.

Suitable temperatures

Rapid heating will not work if the temperature is set to less than 100 °C. If the temperature in the cooking compartment is only slightly less than the temperature you have set, rapid heating is not necessary. It will not switch on.

Setting rapid heating

Press the »||| button to activate rapid heating. The »||| symbol appears next to the temperature you have set. The temperature indicator bars start filling in.

Once all the bars are filled, rapid heating is complete. You will hear a short signal. The »||| symbol goes out. Place your dish in the cooking compartment.

Notes

- Rapid heating is cancelled if you change the type of heating.
- If a cooking time has been set, this runs independently of rapid heating and counts down immediately when operation is started.
- You can use the i button to check the current cooking compartment temperature during rapid heating.
- To ensure an even cooking result, do not place your dish in the cooking compartment until rapid heating is complete.



Cancelling rapid heating

Press the »||| button. The symbol goes out.



Time-setting options

You can call up the time-setting options menu by pressing the ⏸ button. The following functions are available:

If the oven is switched off:

-  = Set timer
-  = Set clock

If the oven is switched on:

-  = Set timer
-  = Set cooking time
-  = Set a later end time

The brackets around the symbol indicate that this function is selected. Once you have started the oven, the brackets show which time function is currently counting down in the display.

Setting the time-setting options - in brief

1. Press the ⏸ button to open the menu.
2. Select the desired function with the ✓ button.
3. Set the desired value with the rotary selector.
4. Press the ⏸ button to close the menu.

A detailed description of how to adjust each individual function is provided below.

Short audible signal

If you cannot change or set a value, you will hear a short audible signal.

Setting the timer

The timer runs independently of the oven. You can use it as a kitchen timer and set it at any time, regardless of whether oven is switched on or off.

1. Press the ⏸ button.
The time-setting options menu appears. The  symbol in brackets shows that the timer function is selected.

2. Set the running time for the timer using the rotary selector.
3. Press the ⏸ button to close the menu.

The time counts down in the clock display.

When the time has elapsed

A signal sounds. The time has elapsed. The display shows 00:00. Press the ⏸ button. The display goes out.

Cancelling the timer time

Press the ⏸ button to open the time-setting options menu. Using the rotary selector, turn the time back to 00:00. Press the ⏸ button to close the menu.

Changing the timer time

Press the ⏸ button to open the time-setting options menu. Use the rotary selector to change the time within the next few seconds. Press the ⏸ button to close the menu.

Setting the cooking time

If you set the cooking time for your dish, operation stops automatically once this time has elapsed. The oven stops heating.

Prerequisite: The type of heating and temperature must be set.

Example in the picture: setting for  top/bottom heating, 180 °C, cooking time of 45 minutes

1. Press the ⏸ button.
The time-setting options menu appears. The time-setting options are displayed in the left-hand side of the display. The  timer function is selected.



2. Using the ✓ button, move to the  end time.

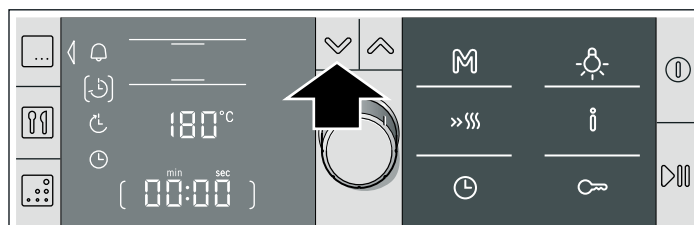

3. Turn the rotary selector to set the cooking time.

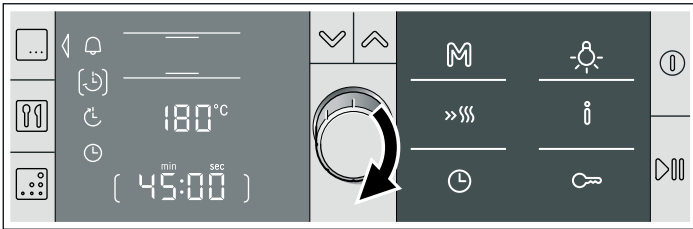

4. Press the button.

The time-setting options menu closes.

5. If the operation has not yet started, press the button.

The time starts counting down.

The cooking time has elapsed

A signal sounds. The oven stops heating. The cooking time is at **00:00**. You can cancel the signal earlier by pressing the button.

Cancelling the cooking time

Press the button to open the menu. Using the button, switch to the cooking time and use the rotary selector to set the cooking time to **00:00**. Press the button to close the menu.

Changing the cooking time

Press the button to open the menu. Using the button, move to the cooking time and set the cooking time using the rotary selector. Press the button to close the menu.

Setting a later end time

A later end time can be set for

- all types of heating
- a variety of programmes
- and the cleaning system

Example: you put the dish in the cooking compartment at 9.30. It takes 45 minutes to cook and will be ready at 10.15, but you would like it to be ready at 12.45 instead.

Change the end time from 10.15 to 12.45. Cooking starts at 12.00 and finishes at 12.45.

Please remember that easily spoiled foods must not be allowed to remain in the cooking compartment for too long.

Setting a later end time

Prerequisite: a cooking time has already been set. Operation has not yet begun. The time-setting options menu is opened.

1. Using the button, move to the end time .

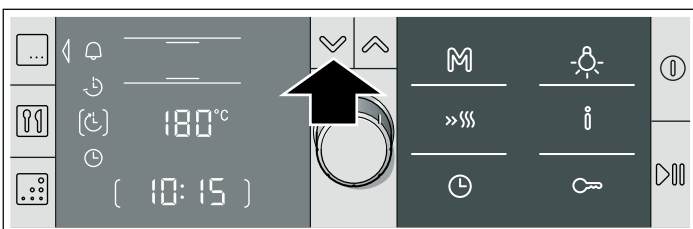

2. Using the rotary selector, set a later end time.



3. Press the button to close the time-setting options menu.

4. Confirm by pressing the button.

The oven is in standby. The end time is shown in the clock display. As soon as operation starts, you will see the cooking time counting down.

The cooking time has elapsed

A signal sounds. The oven stops heating. **00:00** is shown on the clock display. You can stop the audible signal by pressing the button.

Correcting the end time

This is only possible as long as the oven is in standby. Press the button to open the menu. Move to the end time using the button. Adjust the end time using the rotary selector. Press the button to close the menu.

Cancelling the end time

This is possible, providing the oven is on standby. Select the menu with the button and move to the end time using the button. Turn the rotary selector anti-clockwise until the current end time is reached. The cooking time immediately starts to count down.

Setting the clock

The oven must be switched off before you can set or change the clock.

Following a power cut

After a power cut and **00:00** appears in the display. Set the current time.

1. Press the button.

The selected function and [**12:00**] appear in the display.

2. Turn the rotary selector to set the current time.

3. Confirm by pressing the button.

The time appears in the display.

Changing the clock

If you wish to change the clock from summer to winter time, for example:

1. Press the button.

The time-setting options menu appears.

2. Move to the clock using the button.

3. Turn the rotary selector to set the current time.

4. Press the button.

The time appears in the display.

Hiding the clock

You can hide the clock. Then it will only appear when the oven is switched on. For more information, refer to the *Basic settings* section.



Memory

You can save the settings for a dish in the memory and call it up again at any time.

The memory is useful for if you frequently prepare a specific dish.

Saving settings in the memory

The cleaning system cannot be saved.

1. Specify the type of heating, temperature and, if required, a cooking time for the dish you wish to cook. Do not start. If you want to save a programme: Select the programme and enter the weight. Do not start.
2. Press and hold the  button until the  symbol lights up on the display. This will take a few seconds.



The setting is saved and can be started at any time.

Saving another setting

Enter and save the new setting. The old settings are overwritten.

Starting the memory

You can start cooking at any time using the settings saved for your dish.

1. Press the  button briefly.
The saved settings are displayed.
2. Press the  button.
The memory setting starts.

Changing the settings

This can be done at any time. The setting you originally saved appears the next time you start the memory.







Sabbath mode



When this setting is used, the temperature of the oven remains at between 85 °C and 140 °C with Top/bottom heating. You can set a time between 24 and 73 hours.

You can keep dishes in the cooking compartment hot for this time without having to switch the oven on or off.

Starting Sabbath mode

Prerequisite: "Sabbath mode, yes" is activated in the basic settings. See the *Basic settings* section.

1. Press the  button.
 3D hot air and 160 °C are suggested in the display.
2. Turn the rotary selector anti-clockwise to  Sabbath mode.
3. Use the  button to switch to the temperature and set the desired temperature using the rotary selector.
4. Use the  button to open the Time-setting options menu and switch to [] Cooking time with the  button.
27:00 hours are suggested.

5. Turn the rotary selector to set the required cooking time.
6. Press the  button.
The time-setting options menu closes.
7. Press the  button.
The Sabbath mode starts. You can see the cooking time counting down in the status bar.

The cooking time has elapsed

The oven stops heating.

Setting a later end time

It is not possible to set a later end time.



Cancelling Sabbath mode

Press and hold the  button until 3D hot air, 160 °C appears. You can make new settings.

Childproof lock

The oven has a childproof lock to prevent children from switching it on or changing a setting by accident.



Activating the childproof lock

Press and hold the  key button until the  symbol appears. This takes about 4 seconds.

The control panel is locked.

Releasing the lock

Press and hold the  button until the symbol disappears. You can make settings again.

Note: You can still switch the oven off, set the timer and switch the audible signal off when the childproof lock is active by pressing  or by pressing and holding the  button.

Basic settings

Your appliance has various basic settings, which you can adjust to suit your needs at any time.

Note: In the table you will find all the basic settings and the associated options for changing them. Only the basic settings that correspond to the features of your specific appliance are displayed.

Function	Basic setting	Options
c 1 Audible signal after a time has elapsed	2 = 2 minutes	1 = 10 seconds 2 = 2 minutes 3 = 5 minutes
c 2 Confirmation tone when a button is pressed.	0 = off	0 = off 1 = on
c 3 Brightness of the display lighting	3 = day	1 = night 2 = medium 3 = day
c 4 Display clock when the oven is switched off	1 = on	0 = off* * The clock is shown while the residual heat is displayed. 1 = on
c 5 Oven light during operation	1 = on	0 = off 1 = on
c 6 Continue operation when the oven door is closed	1 = operation continues automatically	0 = continue operation with ▷00 1 = operation continues automatically
c 7 Additional door lock for childproof lock	0 = no	0 = no 1 = yes
c 8 Length of cooling fan run-on time	2 = medium	1 = short 2 = medium 3 = long 4 = very long
c 9 Self-cleaning ceiling and side panels are retrofitted	0 = no	0 = no 1 = yes
c 10 Telescopic shelves are retrofitted	0 = no	0 = no 1 = yes
c 11 Undo all changes and restore basic settings.	0 = no	0 = no 1 = yes
c 12 Sabbath mode	0 = no	0 = no 1 = yes

Changing the basic settings

Prerequisite: The oven must be switched off.

Have a look at the table containing the basic settings so that you know what the numbers mean.

Example in the picture: changing the cooling fan run-on time basic setting from medium to short.

1. Press and hold the **i** button for approximately 4 seconds until the first basic setting appears in the display.

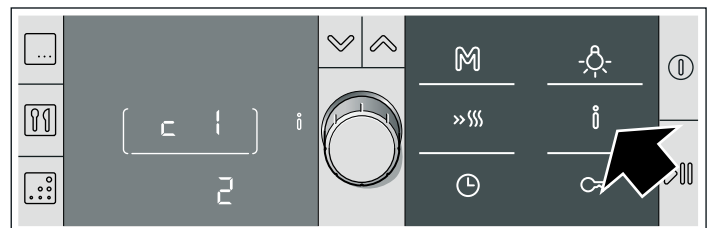

2. Turn the rotary selector to select the required basic setting

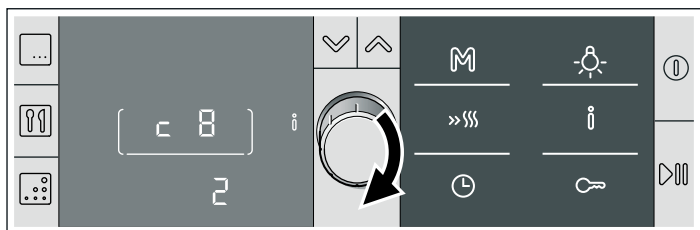

3. Press the button.

4. Change the basic setting by turning the rotary selector.

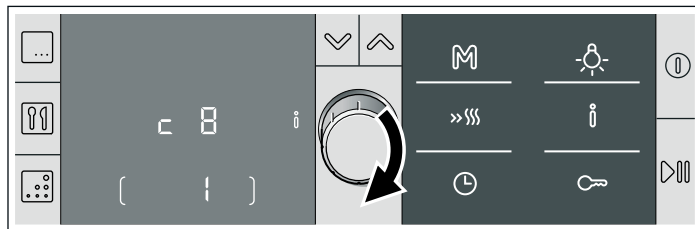

5. You can now change other basic settings, as described in points 2 to 4.

6. Press and hold the button until the clock appears. This takes about four seconds. All changes are saved.

Cancelling

Press the button. The changes are not applied.

Automatic switch-off

Your oven has an automatic switch-off function. It is activated if no cooking time is set and the settings have not been changed for a long time. The point at which this occurs depends on the temperature or grill setting that has been set.

Switch-off activated

appears in the display. Operation is interrupted.

Press any button to make the display message go out. You can make new settings.

Note: If a cooking time is set, the oven stops heating once the cooking time has elapsed. The automatic switch-off function is not necessary.

Cleaning system

The cleaning system regenerates the self-cleaning surfaces in the cooking compartment.

The self-cleaning surfaces are coated with a highly porous ceramic layer. This coating absorbs and disintegrates splashes from baking and roasting while the oven is in operation. If the surfaces no longer clean sufficiently and dark stains appear, they can be regenerated with the cleaning system.

Retrofitting the self-cleaning ceiling and side walls

The back wall in the cooking compartment is coated with ceramic. In order for you to be able to use the cleaning system, the ceiling and side walls must also be coated. You can obtain the self-cleaning ceiling and side walls as a special accessory from the after-sales service.

Changing the basic settings

When you have retrofitted the self-cleaning ceiling and side walls, you must activate the cleaning system in the basic settings. To find out how to do this, refer to the *Basic settings* section.

Cleaning levels

You can choose from three cleaning levels.

Level	Degree of cleaning	Duration
1	gentle	approx. 45 minutes
2	moderate	approx. 1 hour
3	intensive	approx. 1 hour, 15 minutes

Before cleaning

Remove accessories and cookware from the cooking compartment.

Cleaning the cooking compartment floor

Before you set the cleaning system, clean the surfaces in the cooking compartment that are not self-cleaning. Otherwise, stains will develop that it is not possible to remove.

Use a dish cloth and hot soapy water or a vinegar solution. If there are heavy deposits of dirt, use a stainless steel scouring pad or oven cleaner. Only use when the cooking compartment is cold. Never treat the self-cleaning surfaces with a scouring pad or oven cleaner.

Setting the cleaning level

1. Press the button.

Cleaning level 3 is suggested. You can start the cleaning process immediately with the button.

If you wish to change the cleaning level:

2. Select the desired cleaning level using the rotary selector.

3. Press the button to start the cleaning operation.

The time counts down.

Once cleaning has finished

The oven stops heating. appears in the display.

Cancelling the setting

Press and hold the button until 3D hot air, 160 °C appears. You can make new settings.

Adjusting the cleaning level

Once cleaning starts, the cleaning level can no longer be changed.

Setting cleaning to run overnight

So that you can use your oven throughout the day, delay the end of the cleaning process to during the night. See the *Time-setting options* section, setting a later end time.

After cleaning

When the cooking compartment has cooled down completely, wipe the salt residues off the self-cleaning surfaces with a damp cloth.

Care and cleaning

With good care and cleaning, your oven will remain clean and fully-functioning for a long time to come. Here we will explain how to maintain and clean your oven correctly.

Notes

- Slight differences in the colours on the front of the oven are caused by the use of different materials, such as glass, plastic and metal.
- Shadows on the door panel which look like streaks, are caused by reflections made by the oven light.
- Enamel is baked on at very high temperatures. This can cause some slight colour variations. This is normal and does not affect their function. The edges of thin trays cannot be completely enamelled. As a result, these edges can be rough. This will not impair the anti-corrosion protection.

Cleaning agents

To ensure that the different surfaces are not damaged by using the wrong cleaning agent, observe the information in the table. Do not use

- sharp or abrasive cleaning agents,
- cleaning agents with a high concentration of alcohol,
- hard scouring pads or sponges,
- high-pressure cleaners or steam cleaners.

Wash new sponge cloths thoroughly before use.

Area	Cleaning agents
Oven front	Hot soapy water: Clean with a dish cloth and dry with a soft cloth. Do not use glass cleaners or glass scrapers.
Stainless steel	Hot soapy water: Clean with a dish cloth and dry with a soft cloth. Remove flecks of limescale, grease, starch and albumin (e.g. egg white) immediately. Corrosion can form under such residues. Special stainless steel cleaning products suitable for warm surfaces are available from our after-sales service or from specialist retailers. Apply a thin layer of the cleaning product with a soft cloth.
Door panels	Glass cleaner: Clean with a soft cloth. Do not use a glass scraper.
Glass cover for the oven light	Hot soapy water: Clean with a dish cloth.
Seal Do not remove.	Hot soapy water: Clean with a dish cloth. Do not scour.
Shelves	Hot soapy water: Soak and clean with a dish cloth or brush.
Telescopic shelves	Hot soapy water: Clean with a dish cloth or a brush. Do not soak or clean in the dishwasher.
Accessories	Hot soapy water: Soak and clean with a dish cloth or brush.

Cleaning the self-cleaning surfaces in the cooking compartment

The back wall in the cooking compartment is coated with a highly porous ceramic layer. This coating absorbs and disintegrates splashes from baking and roasting while the oven is in operation. The higher the temperature and the longer the oven is in operation, the better the result will be.

If splashes are still visible even after repeated use, proceed as follows:

1. Clean the floor, ceiling and side panels of the cooking compartment thoroughly.
2. Set  3D hot air.
3. With the door closed, heat up the empty oven for approximately 2 hours at maximum temperature.

The ceramic coating is regenerated. When the cooking compartment has cooled down, remove the brown or white residue with water and a soft sponge.

Light discolouration of the coating does not affect automatic self-cleaning.

If you buy the "self-cleaning ceiling and side panels" optional accessory at a later stage, you can regenerate the self-cleaning surfaces with the cleaning system. For this, please see the *Cleaning system* section.

Caution!

- Never use abrasive cleaning agents. You will scratch or destroy the highly porous coating.
- Never treat the ceramic coating with oven cleaner. If oven cleaner accidentally gets onto it, remove it immediately with a sponge and plenty of water.

Cleaning the cooking compartment floor, ceiling and side walls

Use a dish cloth and hot soapy water or a vinegar solution.

If there are heavy deposits of dirt, use a stainless steel scouring pad or oven cleaner. Only use when the cooking compartment is cold. Never treat the self-cleaning surfaces with a scouring pad or oven cleaner.

Detaching and refitting the rails

The rails can be removed for cleaning. The oven must have cooled down.

Detaching the rails

1. Lift up the front of the rail
2. and unhook it (figure A).
3. Then pull the whole rail forward
4. and remove it (Fig. B).

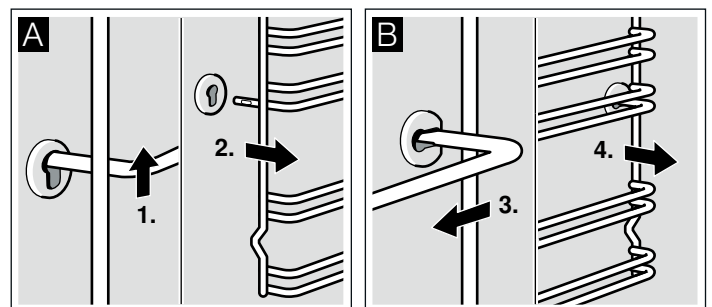

Clean the rails with cleaning agent and a sponge. For stubborn deposits of dirt, use a brush.

Refitting the rails

1. First insert the rail into the rear socket, press it to the back slightly (figure A),
2. and then hook it into the front socket (figure B).

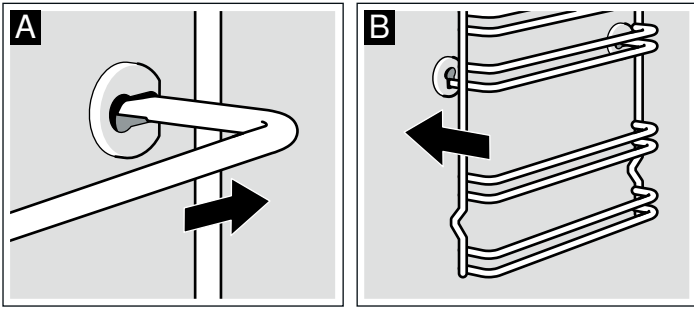

The rails fit both the left and right sides. The kinked section must always be at the bottom.

Folding down the grill element

The grill element can be folded down for cleaning.

⚠ Risk of burns!

The oven must be cold.

1. Pull the handle on the folding grill towards you and push it upwards until you hear it click into place (figure A).
2. At the same time, take hold of the grill element and fold it down (figure B).

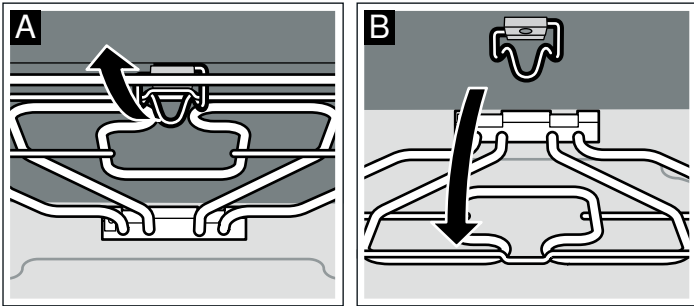

After cleaning, fold the grill element back up. Push the handle down until the grill element clicks into place.

Detaching and attaching the oven door

For cleaning purposes and to remove the door panels, you can detach the oven door.

The oven door hinges each have a locking lever. When the locking levers are closed (figure A), the oven door is secured in place. It cannot be detached. When the locking levers are open in order to detach the oven door (Fig. B), the hinges are locked. They cannot snap shut.

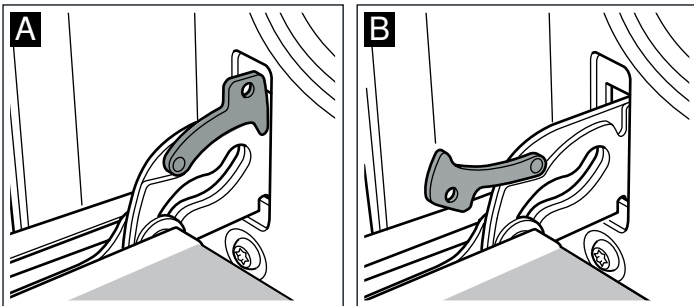

⚠ Risk of injury!

Whenever the hinges are not locked, they snap shut with great force. Ensure that the locking levers are always fully closed or, when detaching the oven door, fully open.

Detaching the door

1. Open the oven door fully.
2. Fold up the two locking levers on the left and right (figure A).
3. Close the oven door as far as the limit stop. With both hands, grip the door on the left and right-hand sides. Close the door a little further and pull it out (figure B).

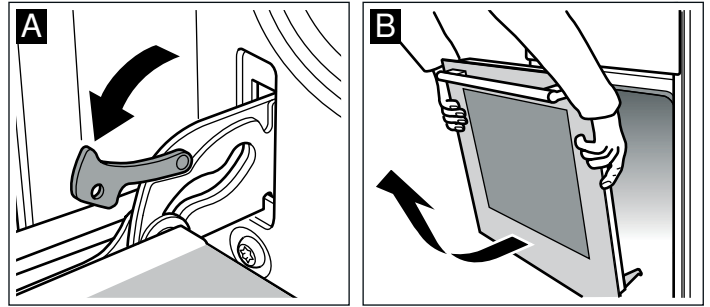

Attaching the door

Reattach the oven door in the reverse sequence to removal.

1. When attaching the oven door, ensure that both hinges are inserted straight into the opening (figure A).
2. The notch on the hinge must engage on both sides (figure B).

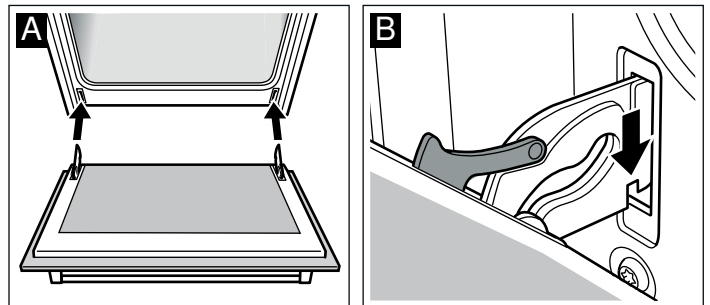

3. Fold back both locking levers (figure C). Close the oven door.

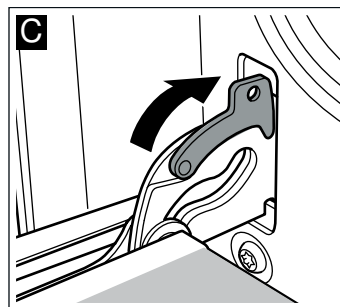

⚠ Risk of injury!

If the oven door falls out accidentally or a hinge snaps shut, do not reach into the hinge. Call the after-sales service.

Removing and installing the door panels

To facilitate cleaning, you can remove the glass panels from the oven door.

When removing the inner panels, pay attention to the order in which the panels are removed. In order to reassemble the panels in the correct sequence, follow the number which appears on each panel.

Removal

1. Detach the oven door and lay on a cloth with the handle facing down.
2. Unscrew the cover at the top of the oven door. To do this, undo the left and right screws (fig. A).
3. Lift the top panel up and out (fig. B).

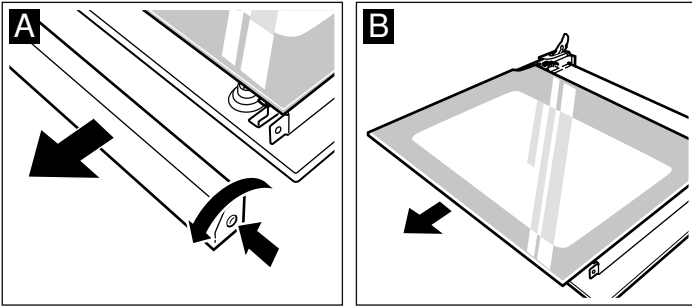

4. Unscrew the retaining clips on the right and left and remove them (fig. C). Remove the middle panel.

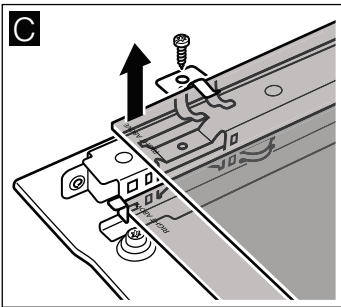

5. Pull the lower panel diagonally upwards and out.
Clean the panels with glass cleaner and a soft cloth.
Do not use sharp or abrasive materials or a glass scraper. This may damage the glass.

Fitting

When fitting, make sure that the lettering "right above" is upside down at the bottom left on both panels.

1. Insert the lower panel diagonally towards the back (fig. A).
2. Insert the centre panel (fig. B).

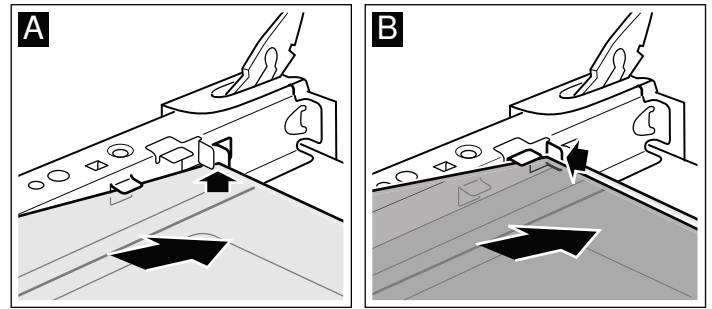

3. Stick the retaining clips onto the right and left-hand side of the panel, aligning them so that the carriers are over the screw holes, and then screw in place (fig. C).

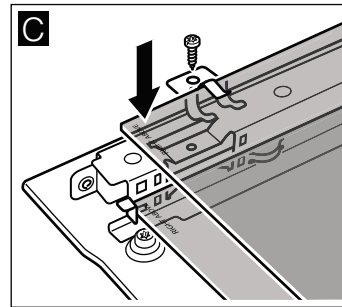

4. Insert the uppermost panel diagonally towards the back. The smooth surface must face outwards.
5. Put the cover back in place and screw it on.
6. Attach the oven door.

Do not use the oven again until the panels have been correctly fitted.

Troubleshooting

Malfunctions often have simple explanations. Refer to the table before calling the after-sales service as you may be able to remedy the fault yourself.

Malfunction table

If a dish does not turn out exactly as you wanted, refer to the *Tested for you in our cooking studio* section, where you will find plenty of cooking tips and tricks.

Problem	Possible cause	Note/remedy
The appliance does not work.	Defective fuse	Look in the fuse box and check that the circuit breaker is in working order.
00:00 appears in the display.	Power cut	Reset the clock.
The oven does not heat up or the type of heating selected cannot be set.	Type of heating not recognised	Make the settings again.
The oven does not heat up. A small square lights up in the temperature display.	The oven is in demo mode.	Switch off the circuit breaker in the fuse box, then switch it back on after at least 20 seconds. Within the next 2 minutes, press and hold the  button for 4 seconds until the square disappears from the display.

Risk of electric shock!

Incorrect repairs are dangerous. Repairs may only be carried out by one of our trained after-sales engineers.

Problem	Possible cause	Note/remedy
When you press the  button, no appears in the display.	The ceiling and side parts in the cooking compartment are not self-cleaning. The cleaning system cannot be run.	You can only set the cleaning system if you have retrofitted the self-cleaning ceiling and side parts and activated the cleaning system in the basic settings. See the <i>Cleaning system</i> section and the <i>Basic settings</i> section.
" FB " appears on the display.	Automatic switch-off has been activated. The oven stops heating.	Press any button.

Error messages with **E**

If an error message with **E** is shown in the display, press the  button. This cancels the error message. You may then have to

reset the time. If the error is shown again, call the after-sales service.

You can take remedial action yourself if the following error message is displayed.

Error message	Possible cause	Note/remedy
E011	A button has been pressed for too long.	Press all buttons individually. Check that the buttons are clean. If the error message remains, please contact the after-sales service.

Replacing the bulb in the oven ceiling light

If the bulb in the oven light fails, it must be replaced. Heat-resistant, 40 watt spare bulbs can be obtained from our after-sales service or a specialist retailer. Only use these bulbs.

Risk of electric shock!

Switch off the circuit breaker in the fuse box.

1. Place a tea towel in the oven when it is cold to prevent damage.
2. Unscrew the glass cover by turning it anti-clockwise.

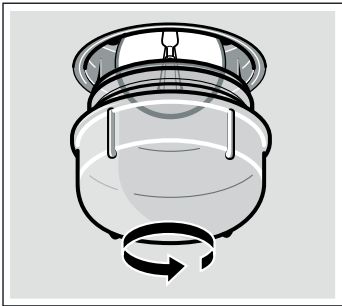

3. Replace the bulb with one of the same type.
4. Screw the glass cover back in.
5. Remove the tea towel and switch on the circuit breaker.

Replacing the bulb in the left-hand oven light

If the bulb in the oven light fails, it must be replaced. Heat-resistant, 25 watt spare bulbs can be obtained from our after-sales service or a specialist retailer. Only use these bulbs.

Risk of electric shock!

Switch off the circuit breaker in the fuse box.

1. Place a tea towel in the oven when it is cold to prevent damage.
2. Remove the glass cover. To do this, open the glass cover from the bottom with your hand (Fig. A). If the glass cover is difficult to remove, use a spoon as an aid.

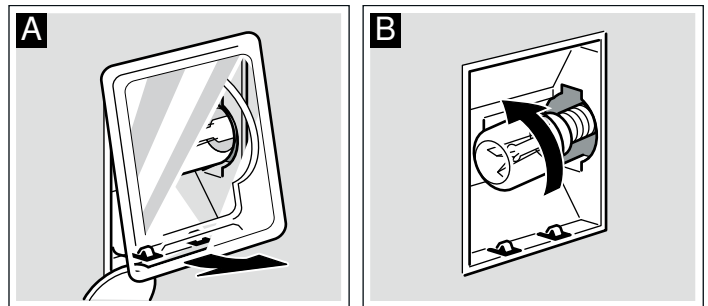

3. Unscrew the bulb and replace it with one of the same type (Fig. B). When fitting the new bulb, make sure that it is screwed in straight.
4. Refit the glass cover. Make sure that the curvature in the glass is on the right. Insert the glass at the top and push it in firmly at the bottom (Fig. C). The glass cover will click into place.

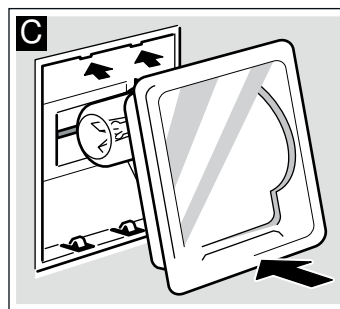

5. Remove the tea towel and switch on the circuit breaker.

Glass cover

You must replace a damaged glass cover. Suitable glass covers may be obtained from the after-sales service. Please specify the E number and FD number of your appliance.

After-sales service

Our after-sales service is there for you if your appliance needs to be repaired. We will always find the right solution in order to avoid unnecessary visits from a service technician.

E number and FD number

When calling us, please give the product number (E no.) and the production number (FD no.) so that we can provide you with the correct advice. The rating plate containing these numbers can be found on the right-hand side of the oven door. You can make a note of the numbers of your appliance and the telephone number of the after-sales service in the space below to save time should it be required.

E no.	FD no.
After-sales service ☎	

Please note that there will be a fee for a visit by a service technician in the event of a malfunction, even during the warranty period.

Please find the contact data of all countries in the enclosed customer service list.

To book an engineer visit and product advice

GB 0844 8928979

Calls from a BT landline will be charged at up to 3 pence per minute. A call set-up fee of up to 6 pence may apply.

IE 01450 2655

Trust the expertise of the manufacturer, and rest assured that the repair will be carried out by trained service technicians using original spare parts for your domestic appliance.

Energy and environment tips

Here you can find tips on how to save energy when baking and roasting and how to dispose of your appliance properly.

Saving energy

- Only preheat the oven if this is specified in the recipe or in the operating instruction tables.
- Use dark, black lacquered or enamelled baking tins. They absorb the heat particularly well.
- Open the oven door as infrequently as possible while you are cooking, baking or roasting.
- It is best to bake several cakes one after the other. The oven is still warm. This reduces the baking time for the second cake. You can also place two loaf tins next to each other.

- For longer cooking times, you can switch the oven off 10 minutes before the end of the cooking time and use the residual heat to finish cooking.

Environmentally-friendly disposal

Dispose of packaging in an environmentally-friendly manner.



This appliance complies with European Directive 2002/96/EC on Waste Electrical and Electronic Equipment (WEEE). The directive gives a framework for the collection and recycling of old appliances, which is valid across the EU.

Automatic programmes

The automatic programmes help you to achieve elaborate pot roasts, juicy roasts and delicious stews very easily. You do not have to worry about turning and basting and the cooking compartment remains clean.

The cooking result depends on the quality of the meat and the size and type of ovenware. Use an oven cloth or oven gloves when you take the finished dish out of the cooking compartment. The ovenware will be very hot. Take care when opening the ovenware, as hot steam will escape.

Ovenware

Automatic programmes are only suitable for roasting meat in ovenware with lid, with the exception of browning a ham joint. Only use ovenware with a tightly fitting lid. Also observe the information from the ovenware manufacturer.

Suitable cookware

We recommend heat-resistant cookware (up to 300 °C) made from glass or glass ceramic. Roasting dishes made from stainless steel are not ideal. Their shiny surface reflects a high proportion of the thermal radiation. The food will not brown as much and the meat will be less well cooked. If you use a stainless-steel roasting dish, remove the lid once the

programme has finished. Grill the meat at grill setting 3 for 8 to 10 minutes more. The dish browns more quickly if you use a roasting dish made of enamelled steel, cast iron or diecast aluminium. Add a little more liquid.

Unsuitable cookware

Cookware made of bright, shiny aluminium, unglazed clay or plastic, and cookware with plastic handles, is not suitable.

Size of the ovenware

The meat should cover about two thirds of the ovenware base. This will ensure that you get good meat juices.

The distance between the meat and the lid must be at least 3 cm. The meat may expand during the roasting process.

Preparing the dish

You can use fresh or frozen meat. We recommend fresh chilled meat.

Select a suitable roasting dish.

Weigh the fresh or frozen meat, poultry or fish. You will find detailed information in the corresponding tables. You need the weight in order to make the setting.

Season the meat. Season frozen meat in the same way as fresh meat.

Many dishes require the addition of liquid. Pour enough liquid into the ovenware so that the base is covered to a depth of approx. ½ cm. If the table specifies "a little" liquid, 2-3 tablespoons are usually sufficient. If the table says "Yes", feel free to add more. Observe the instructions given before and in the tables.

Cover the ovenware with a lid. Place it on the wire rack at level 2.

For some dishes, it is not possible to set a later end time. These dishes are marked with an asterisk *.

Always place the ovenware into the cooking compartment without preheating it.

Programmes

Poultry

Place poultry in the roasting dish, breast side up. The programme is not suitable for stuffed poultry.

When cooking several drumsticks, set the weight of the heaviest drumstick. The drumsticks must be approximately the same weight.

Example: For 3 chicken drumsticks of 300 g, 320 g and 400 g, set 400 g.

Just as with drumsticks, if you want to prepare two chickens of similar size in one roasting dish, make settings according to the weight of the heavier chicken.

Programmes	Programme number	Weight range in kg	Add liquid	Weight setting
Poultry				
Chicken, fresh	P1*	0.7-2.0	No	Weight of meat
Poulard, fresh	P2*	1.4-2.3	No	Weight of meat
Duck, fresh	P3*	1.6-2.7	No	Weight of meat
Goose, fresh	P4*	2.5-3.5	No	Weight of meat
Small turkey, fresh	P5*	2.5-3.5	No	Weight of meat
Drumsticks, fresh, e. g. chicken, duck, goose, turkey drumsticks	P6*	0.3-1.5	No	Weight of heaviest drumstick

Meat

Pour the specified amount of liquid into the ovenware.

Beef

When cooking pot roasts, ensure that sufficient liquid is added. You can also use the marinade. Cook sirloin fatty-side up.

Programmes	Programme number	Weight range in kg	Add liquid	Weight setting
Beef				
Pot roast, fresh e. g. prime rib, boned shoulder, shoulder, marinated beef	P7	0.5-3.0	Yes	Weight of meat
Pot roast, frozen e. g. prime rib, boned shoulder, shoulder	P8*	0.5-2.0	Yes	Weight of meat
Sirloin, fresh, rare e. g. loin	P9	0.5-2.5	No	Weight of meat
Veal				
Joint, fresh, lean e. g. topside, flank	P10	0.5-3.0	Yes	Weight of meat
Joint, fresh, marbled e. g. neck, scrag end	P11	0.5-3.0	A little	Weight of meat
Knuckle on the bone, fresh	P12	0.5-2.5	Yes	Weight of meat
Lamb				
Leg, fresh, boned, well done	P13	0.5-2.5	A little	Weight of meat
Leg, fresh, boned, medium	P14	0.5-2.5	No	Weight of meat
Leg, fresh, on the bone, well done	P15	0.5-2.5	A little	Weight of meat
Leg, frozen, boned, well-done	P16*	0.5-2.0	A little	Weight of meat
Leg, frozen, on the bone, well done	P17*	0.5-2.0	A little	Weight of meat

Game

Game can be covered with bacon, which keeps the meat more succulent, but means that it will not brown as much. To create a more delicate taste, you can marinate the game overnight in the fridge in buttermilk, wine or vinegar, before cooking.

When cooking more than one haunch of hare, set the weight of the heaviest haunch.

Rabbit can also be cooked pre-cut into portions. Set the total weight.

Game	Programme number	Weight range in kg	Add liquid	Weight setting
Joint of venison, fresh e. g. shoulder, breast	P18	0.5-3.0	Yes	Weight of meat
Boned leg of roe venison, fresh	P19	0.5-3.0	Yes	Weight of meat
Hare haunch on the bone, fresh	P20	0.3-0.6	Yes	Weight of meat
Rabbit, fresh	P21	0.5-3.0	Yes	Weight of meat

Fish

Prepare the fish, then add vinegar, lemon juice or white wine and salt as usual.

For braised fish: Pour some liquid (e. g. wine or lemon juice) into the cookware, ½ cm deep.

For baked fish: Turn the fish in flour and brush with melted butter.

Whole fish turns out particularly well if it is placed in the dish in a swimming position. In other words, the dorsal fin is pointing upwards. To ensure that the fish remains in position, place half a potato or a small, ovenproof container into the stomach cavity.

When cooking more than one fish, set the total weight. However, the fish must be roughly the same size or the same weight. Example: For two trout of 0.6 kg and 0.5 kg, set 1.1 kg.

Programmes	Programme number	Weight range in kg	Add liquid	Weight setting
Fish				
Trout, fresh, braise	P22*	0.3-1.5	Yes	Total weight
Trout, fresh, bake	P23*	0.3-1.5	No	Total weight
Cod, fresh, braise	P24*	0.5-2.0	Yes	Total weight
Cod, fresh, bake	P25*	0.5-2.0	No	Total weight

Stew

You can combine various types of meat and fresh vegetables.

Cut the meat into bite-sized pieces. Use whole chicken portions.

Add between the same and double the quantity of vegetables to the meat. Example: For 0.5 kg of meat, add 0.5 kg to 1 kg of fresh vegetables.

If you wish the meat to brown, add it as the last ingredient to the roasting dish on top of the vegetables. If you do not want it

to brown so much, mix the meat in among the vegetables.

When cooking a stew with meat, set the weight of the meat. If you want the vegetables to be softer, set the total weight.

Firm types of vegetables are suitable for making vegetable stew, such as carrots, green beans, white cabbage, celery and potatoes. The smaller you cut the vegetables, the softer they will become. So that the vegetables are not browned too much, cover them with liquid.

Programmes	Programme number	Weight range in kg	Add liquid	Weight setting
Stew				
With meat e. g. beef stew	P26	0.3-3.0	Yes	Weight of meat
With vegetables e. g. vegetable stew	P27	0.3-3.0	Yes	Total weight
Goulash	P28	0.3-3.0	Yes	Weight of meat
Roulades	P29	0.3-3.0	Yes	Weight of meat

Meat loaf

Use fresh minced meat.

Set the total weight of the meat loaf.

The recipe can be improved by adding diced vegetables or cheese.

Programmes	Programme number	Weight range in kg	Add liquid	Weight setting
Meat loaf				
Made from fresh beef	P30	0.3-3.0	No	Total weight
Made from fresh lamb	P31*	0.3-3.0	No	Total weight
Made from fresh, mixed meat	P32*	0.3-3.0	No	Total weight
Made from fresh pork	P33*	0.3-3.0	No	Total weight

Pork

Joints with a crust should be placed in the dish with the crust side up. Score the rind to make a grid-like pattern, without cutting into the meat.

Place ham joints in the dish with the layer of fat facing upwards. Cook in an uncovered dish until a brown crust forms.

When roasting joints of meat, set the weight of the meat. For rolled roasting joints, set the total weight.

Programmes	Programme number	Weight range in kg	Add liquid	Weight setting
Pork				
Neck joint, fresh, boned	P34	0.5-3.0	Yes	Weight of meat
Neck joint, frozen, boned	P35*	0.5-2.0	Yes	Weight of meat
Roast loin, fresh	P36	0.5-2.5	Yes	Weight of meat
Rolled roasting joint, fresh	P37	0.5-3.0	Yes	Total weight
Joint with crust, fresh, belly	P38	0.5-3.0	No	Weight of meat
Ham joint, fresh, cured, cook	P39	1.0-4.0	A little	Weight of meat
Ham joint, fresh, cured, brown	P40*	1.0-4.0	No	Weight of meat

Selecting and setting a programme

First choose a suitable programme from the programme table.

Example in the diagram: setting for pot-roasted beef, fresh, programme 7, weight of meat 1.3 kg.

1. Press the  button.

The first programme number appears in the temperature display.

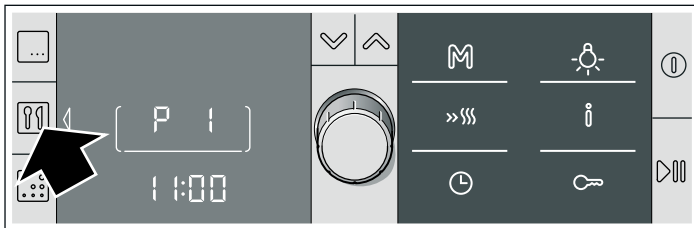

2. Select the desired programme number using the rotary selector.

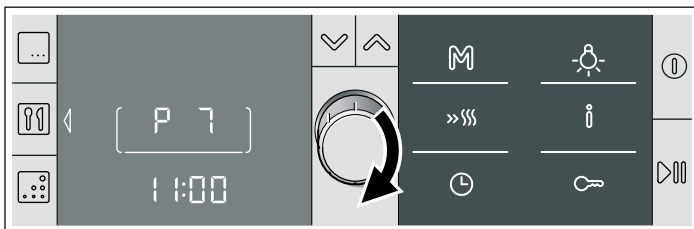

3. Press the  button.

A weight is suggested in the clock display.

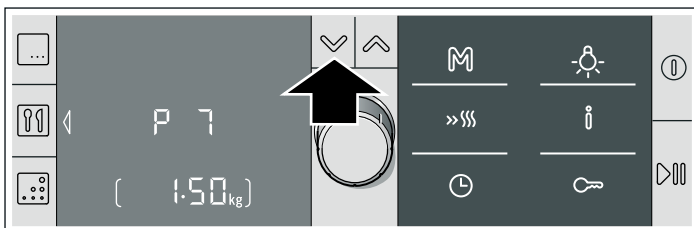

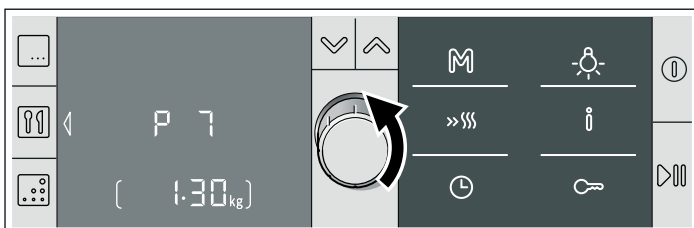

4. Use the rotary selector to specify the weight of the dish.

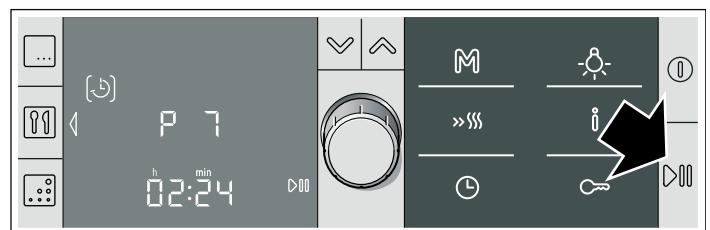

5. Press the  button.

The programme length is shown.



The programme starts. You will see the cooking time [] counting down on the clock display.

The programme has ended

A signal sounds. The oven stops heating. You can cancel the signal earlier by pressing the  button.

Changing the programme duration

The duration of the programme cannot be changed.



Changing the programme

Once a programme has been started, it can no longer be changed.



Opening the oven door during cooking

Operation is suspended. When the door is closed again, operation resumes.

Pausing operation

Press the  button briefly. The oven is paused. Press the  button again to continue operation.



Cancelling the programme

Press and hold  button until the  symbol for 3D hot air and 160 °C appear. You can now change the settings.

Setting a later end time

See the section entitled *Time-setting options - Setting a later end time*.

Tips for the automatic programmes

The weight of the joint or poultry is greater than the weight ranges available.	The weight range is deliberately limited. For very large joints, it is often impossible to obtain a sufficiently large roasting dish. Prepare large pieces with  Top/bottom heating or  Hot air grilling.
The joint has cooked well, but the juices are too dark.	Select a smaller dish or use more liquid.
The joint has cooked well, but the juices are too clear and watery.	Select a larger dish or use less liquid.
The joint is too dry on the top.	Use a dish with a tightly fitting lid. Very lean meat will remain more succulent if it is covered with rashers of bacon.
The joint looks good, but there was a burning smell during roasting.	The lid of the roasting dish is not closed properly, or the meat has expanded and has pushed up the lid. Always use the right lid for your ovenware. Make sure that there is at least 3 cm between the meat and the lid.
You wish to prepare frozen meat.	Season frozen meat in the same way as fresh meat. Caution: For frozen meat it is not possible to delay the end time. The meat would defrost during the waiting time and would be inedible.

Tested for you in our cooking studio

Here you will find a selection of dishes and the ideal settings for them. We will show you which type of heating and which temperature are best suited for your dish. You can find information about suitable accessories and the height at which they should be inserted. There are also tips about cookware and preparation methods.

Notes

- The values in the table always apply to dishes placed into the cooking compartment when it is cold and empty. Only preheat the appliance if the table specifies that you should do so. Do not line the accessories with greaseproof paper until after they have been preheated.
- The times specified in the tables are guidelines only. They will depend on the quality and composition of the food.
- Use the accessories supplied. Additional accessories may be obtained as special accessories from specialist retailers or from the after-sales service. Before using the oven, remove any unnecessary accessories and ovenware from the cooking compartment.
- Always use oven gloves when taking hot accessories or ovenware out of the cooking compartment.

Cakes and pastries

Baking on one level

When baking cakes, the best results can be achieved using  Top/bottom heating.

When baking with  3D hot air, use the following shelf heights for the accessory:

- Cakes in tins: level 2
- Cakes on trays: level 3

Baking on two or more levels

Use  3D hot air.

Shelf heights for baking on 2 levels:

- Universal pan: level 3
- Baking tray: level 1

Shelf heights for baking on 3 levels:

- Baking tray: level 5
- Universal pan: level 3
- Baking tray: level 1

Baking trays that are placed in the oven at the same time will not necessarily be ready at the same time.

The tables show numerous suggestions for your dishes.

If you are baking with 3 cake/loaf tins at the same time, place these on the wire racks as indicated in the picture.

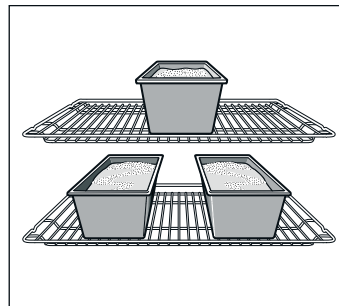

Baking tins

It is best to use dark-coloured metal baking tins.

Baking times are increased when light-coloured baking tins made of thin metal or glass dishes are used, and cakes do not brown so evenly.

If you wish to use silicone baking tins, use the information and recipes provided by the manufacturer as a guide. Silicone baking tins are often smaller than normal tins. The amount of mixture and recipe instructions may differ.

Tables

The tables show the ideal type of heating for the various cakes and pastries. The temperature and baking time depend on the amount and composition of the mixture. This is why temperature ranges are given in the tables. You should try the lower temperature first, since a lower temperature results in more even browning. You can increase the temperature next time if necessary.

If you preheat the oven, the baking time is shortened by 5 to 10 minutes.

Additional information can be found in the *Baking tips* section following the tables.

Note: Due to the high level of moisture when baking with  HydroBake, condensation can form on the inside window of the oven. Open the oven door carefully, as hot steam will escape.

Cakes in tins	Tin	Level	Type of heating	Temperature in °C	Cooking time in minutes
Sponge cake, simple	ring tin/round tin	2	☉	160-180	50-60
	3 loaf tins	3+1	☉	140-160	60-80
Sponge cake, delicate	ring tin/round tin	2	☐	150-170	60-70
Flan base, sponge	flan tin	3	☐	160-180	20-30
Delicate fruit flan, sponge	springform/ring tin	2	☐	160-180	50-60
Sponge base, 2 eggs (preheat)	flan tin	2	☐	160-180	20-30
Sponge flan, 6 eggs (preheat)	springform cake tin	2	☐	160-180	40-50
Shortcrust pastry base with crust	springform cake tin	1	☐	180-200	25-35
Fruit tart/cheesecake, pastry base*	springform cake tin	1	☐	160-180	70-90
Swiss flan	pizza tray	1	☐	220-240	35-45
Ring cake	ring cake tin	2	☐	150-170	60-70
Pizza, thin base with light topping (pre-heat)	pizza tray	1	☐	280-300	10-15
Savoury cakes*	springform cake tin	1	☐	170-190	45-55

* Turn off the oven and allow cakes to cool for an additional 20 minutes with the oven door closed.

Cakes on trays	Accessories	Level	Type of heating	Temperature in °C	Cooking time in minutes
Sponge with dry topping	baking tray	2	☐	170-190	20-30
	universal pan + baking tray	3+1	☉	150-170	35-45
Sponge with moist topping (fruit)	universal pan	2	☐	170-190	25-35
	universal pan + baking tray	3+1	☉	140-160	40-50
Yeast dough with dry topping	baking tray	3	☐	170-190	25-35
	universal pan + baking tray	3+1	☉	150-170	35-45
Yeast dough with moist topping (fruit)	universal pan	3	☐	160-180	40-50
	universal pan + baking tray	3+1	☉	150-160	50-60
Shortcrust pastry with dry topping	baking tray	1	☐	180-200	20-30
Shortcrust pastry with moist topping (fruit)	universal pan	2	☐	160-180	60-70
Swiss flan	universal pan	1	☐	210-230	40-50
Swiss roll (preheat)	baking tray	2	☐	170-190	15-20
Plaited loaf with 500 g flour	baking tray	2	☐	180-200	25-35
Stollen with 500 g flour	baking tray	3	☐	160-180	60-70
Stollen with 1 kg flour	baking tray	3	☐	140-160	90-100
Strudel, sweet	universal pan	2	☐	190-210	55-65
Pizza	baking tray	2	☐	220-240	25-35
	universal pan + baking tray	3+1	☉	180-200	40-50
Tarte flambée (preheat)	universal pan	2	☐	280-300	10-12

Small baked items	Accessories	Level	Type of heating	Temperature in °C	Cooking time in minutes
Biscuits	baking tray	3	☉	140-160	15-25
	universal pan + baking tray	3+1	☉	130-150	25-35
	2 baking trays + universal pan	5+3+1	☉	130-150	30-40
Viennese whirls (preheat)	baking tray	3	☐	140-150	30-40
	baking tray	3	☉	140-150	25-35
	universal pan + baking tray	3+1	☉	140-150	30-45
	2 baking trays + universal pan	5+3+1	☉	130-140	35-50

Small baked items	Accessories	Level	Type of heating	Temperature in °C	Cooking time in minutes
Macaroons	baking tray	2	☐	100-120	30-40
	universal pan + baking tray	3+1	☉	100-120	35-45
	2 baking trays + universal pan	5+3+1	☉	100-120	40-50
Meringue	baking tray	3	☉	80-100	100-150
Muffins	wire rack with muffin tray	3	☐	180-200	20-25
	2 wire racks with muffin trays	3+1	☉	160-180	25-30
Choux pastry	baking tray	2	☐	210-230	30-40
Puff pastry	baking tray	3	☉	180-200	20-30
	universal pan + baking tray	3+1	☉	180-200	25-35
	2 baking trays + universal pan	5+3+1	☉	170-190	35-45
Leavened cake	baking tray	3	☐	190-210	20-30
	universal pan + baking tray	3+1	☉	160-180	25-35

Bread and rolls

When baking bread, preheat the oven, unless instructions state otherwise.

Never pour water into the hot oven.

Bread and rolls	Accessories	Level	Type of heating	Temperature in °C	Cooking time in minutes
Yeast bread with 1.2 kg flour	universal pan	2	☐	300	5
				200	30-40
Sourdough bread with 1.2 kg flour	universal pan	2	☐	300	8
				200	35-45
Flatbread	universal pan	2	☐	300	10-15
Bread rolls (do not preheat)	baking tray	3	☐	200-220	20-30
Rolls made with sweet yeast dough	baking tray	3	☐	180-200	15-20
	universal pan + baking tray	3+1	☉	150-170	20-30

Baking tips

You wish to bake according to your own recipe.	Use similar items in the baking tables as a guide.
How to establish whether sponge cake is baked through.	Approximately 10 minutes before the end of the baking time specified in the recipe, stick a cocktail stick into the cake at the highest point. If the cocktail stick comes out clean, the cake is ready.
The cake collapses.	Use less fluid next time or set the oven temperature 10 degrees lower. Observe the specified mixing times in the recipe.
The cake has risen in the middle but is lower around the edge.	Do not grease the sides of the springform cake tin. After baking, loosen the cake carefully with a knife.
The cake goes too dark on top.	Place it lower in the oven, select a lower temperature and bake the cake for a little longer.
The cake is too dry.	When it is done, make small holes in the cake using a cocktail stick. Then drizzle fruit juice or an alcoholic beverage over it. Next time, select a temperature 10 degrees higher and reduce the baking time.
The bread or cake (e.g. cheesecake) looks good, but is soggy on the inside (sticky, streaked with water).	Use slightly less fluid next time and bake for slightly longer at a lower temperature. For cakes with a moist topping, bake the base first. Sprinkle it with almonds or bread crumbs and then place the topping on top. Please follow the recipe and baking times.
The cake is unevenly browned.	Select a slightly lower temperature to ensure that the cake is baked more evenly. Bake delicate pastries on one level using ☐ Top/bottom heating. Protruding greaseproof paper can affect the air circulation. For this reason, always cut greaseproof paper to fit the baking tray.
The bottom of a fruit cake is too light.	Place the cake one level lower the next time.
The fruit juice overflows.	Next time, use the deeper universal pan, if you have one.
Small baked items made out of yeast dough stick to one another when baking.	There should be a gap of approx. 2 cm around each item. This gives enough space for the baked items to expand well and turn brown on all sides.
You were baking on several levels. The items on the top baking tray are darker than that on the bottom baking tray.	Always use ☉ 3D hot air to bake on more than one level. Baking trays that are placed in the oven at the same time will not necessarily be ready at the same time.
Condensation forms when you bake moist cakes.	Baking may result in the formation of water vapour, which escapes above the door. The steam may settle and form water droplets on the control panel or on the fronts of adjacent units. This is a natural process.

Meat, poultry, fish

Ovenware

You may use any heat-resistant ovenware. The universal pan is suitable for large roasts.

Glass ovenware is the most suitable. Ensure that the lid of the roasting dish fits well and closes properly.

Add a little more liquid when using enamelled roasting dishes.

With roasting dishes made of stainless steel, browning is not so intense and the meat may be somewhat less well cooked.

Increase the cooking times.

Information in the tables:

Ovenware without a lid = open

Ovenware with a lid = closed

Always place the ovenware in the centre of the wire rack.

Place hot glass ovenware on a dry mat after cooking. The glass could crack if placed on a cold or wet surface.

Roasting

Add in a little liquid if the meat is lean. Cover the base of the ovenware with approx. ½ cm of liquid.

Add liquid generously for pot roasts. Cover the base of the ovenware with approx. 1 - 2 cm of liquid.

The amount of liquid depends on the type of meat and the material the ovenware is made of. If preparing meat in an enamelled roasting dish, it will need a little more liquid than if cooked in glass ovenware.

Roasting dishes made from stainless steel are not ideal. The meat cooks more slowly and browns less fully. Use a higher temperature and/or a longer cooking time.

Grilling

When grilling, preheat the oven for approx. 3 minutes, before placing the food into the cooking compartment.

Always grill with the oven door closed.

As far as possible, the pieces of food you are grilling should be of equal thickness. This will allow them to brown evenly and remain succulent and juicy.

Turn the food you are grilling after ⅔ of the time.

Do not add salt to steaks until they have been grilled.

Place the food to be grilled directly on the wire rack. If you are grilling a single piece, the best results are achieved by placing it in the centre of the wire rack.

The universal pan should also be inserted at level 1. The meat juices are collected in the pan and the oven is kept cleaner.

When grilling, do not insert the baking tray or universal pan at level 4 or 5. The high heat distorts it and the cooking compartment can be damaged when removing it.

The grill element switches on and off continually. This is normal. The grill setting determines how frequently this will happen.



















Meat

Turn pieces of meat halfway through the cooking time.

When the roast is ready, turn off the oven and allow it to rest for an additional 10 minutes. This allows better distribution of the meat juices.

After cooking, wrap sirloin in aluminium foil and leave it to rest for 10 minutes in the oven.

For roast pork with a rind, score the rind in a crossways pattern, then lay the roast in the dish with the rind at the bottom.

Meat	Weight	Accessories and ovenware	Level	Type of heating	Temperature in °C, grill setting	Cooking time in minutes
Beef						
Pot-roasted beef	1.0 kg	covered	2		200-220	100
	1.5 kg		2		190-210	120
	2.0 kg		2		180-200	140
Fillet of beef, medium	1.0 kg	uncovered	2		210-230	60
	1.5 kg		2		200-220	80
Sirloin, medium	1.0 kg	uncovered	1		220-240	60
Steaks, 3 cm thick, medium		wire rack + universal pan	5+1		3	15
Veal						
Joint of veal	1.0 kg	uncovered	2		190-210	110
	1.5 kg		2		180-200	130
	2.0 kg		2		170-190	150
Knuckle of veal	1.5 kg	uncovered	2		210-230	140
Pork						
Joint without rind (e.g. neck)	1.0 kg	uncovered	1		190-210	120
	1.5 kg		1		180-200	150
	2.0 kg		1		170-190	170
Joint with rind (e.g. shoulder)	1.0 kg	uncovered	1		190-210	130
	1.5 kg		1		180-200	160
	2.0 kg		1		170-190	190
Fillet of pork	500 g	wire rack + universal pan	3+1		230-240	30

Meat	Weight	Accessories and ovenware	Level	Type of heating	Temperature in °C, grill setting	Cooking time in minutes
Pork joint, lean	1.0 kg	uncovered	2		200-220	120
	1.5 kg		2		190-210	140
	2.0 kg		2		180-200	160
Smoked pork on the bone	1.0 kg	covered	2		210-230	70
Steaks, 2 cm thick		wire rack + universal pan	5+1		3	15
Pork medallions, 3 cm thick		wire rack + universal pan	5+1		3	10

Lamb

Saddle of lamb on the bone	1.5 kg	uncovered	2		190-210	60
Leg of lamb, boned, medium	1.5 kg	uncovered	1		160-180	120

Game

Saddle of venison on the bone	1.5 kg	uncovered	2		200-220	50
Leg of roe venison, boned	1.5 kg	covered	2		210-230	100
Wild boar joint	1.5 kg	covered	2		180-200	140
Joint of venison	1.5 kg	covered	2		180-200	130
Rabbit	2.0 kg	covered	2		220-240	60

Minced meat

Meat loaf	Made from 500 g meat	uncovered	1		180-200	80
-----------	----------------------	-----------	---	--	---------	----

Sausages

Sausages		wire rack + universal pan	4+1		3	15
----------	--	---------------------------	-----	--	---	----

Poultry

The weights indicated in the table refer to oven-ready poultry (without stuffing).

Place whole poultry on the lower wire rack breast-side down. Turn after $\frac{2}{3}$ of the specified time.

Turn roasts, such as rolled turkey joint or turkey breast, halfway through the cooking time. Turn poultry portions after $\frac{2}{3}$ of the time.

For duck or goose, pierce the skin on the underside of the wings. This allows the fat to run out.

Poultry will turn out particularly crispy and brown if you baste it towards the end of the roasting time with butter, salted water or orange juice.

Poultry	Weight	Accessories and ovenware	Level	Type of heating	Temperature in °C, grill setting	Cooking time in minutes
Chicken, whole	1.2 kg	wire rack	2		220-240	60-70
Pouard, whole	1.6 kg	wire rack	2		210-230	80-90
Chicken, halved	500 g each	wire rack	2		220-240	40-50
Chicken portions	150 g each	wire rack	3		210-230	30-40
Chicken portions	300 g each	wire rack	3		210-230	35-45
Chicken breast	200 g each	wire rack	3		3	30-40
Duck, whole	2.0 kg	wire rack	2		190-210	100-110
Duck breast	300 g each	wire rack	3		240-260	30-40
Goose, whole	3.5-4.0 kg	wire rack	2		170-190	120-140
Goose legs	400 g each	wire rack	3		220-240	40-50
Small turkey, whole	3.0 kg	wire rack	2		180-200	80-100
Rolled turkey joint	1.5 kg	uncovered	1		200-220	110-130
Turkey breast	1.0 kg	covered	2		180-200	80-90
Turkey thigh	1.0 kg	wire rack	2		180-200	90-100







Fish

Turn the pieces of fish after $\frac{2}{3}$ of the time.

Whole fish does not have to be turned. Place the whole fish in the oven in its swimming position with its dorsal fin facing

upwards. Placing half a potato or a small ovenproof container in the stomach cavity of the fish will make it more stable.

For fish fillet, add a few tablespoons of liquid to provide steam.

Fish	Weight	Accessories and ovenware	Level	Type of heating	Temperature in °C, grill setting	Cooking time in minutes
Fish, whole	300 g each (approx.)	wire rack	2		2	20-25
	1.0 kg	wire rack	2		200-220	45-55
	1.5 kg	wire rack	2		190-210	60-70
	2.0 kg	covered	2		190-210	70-80
Fish steak, 3 cm thick		wire rack	3		2	20-25
Fish fillet		covered	2		210-230	25-30

Tips for roasting and grilling

The table does not contain information for the weight of the joint.	Select the next lowest weight from the instructions and extend the time.
How to tell when the roast is ready.	Use a meat thermometer (available from specialist shops) or carry out a "spoon test". Press down on the roast with a spoon. If it feels firm, it is ready. If the spoon can be pressed in, it needs to be cooked for a little longer.
The roast is too dark and the crackling is partly burnt.	Check the shelf height and temperature.
The roast looks good but the juices are burnt.	Next time, use a smaller roasting dish or add more liquid.
The roast looks good but the juices are too clear and watery.	Next time, use a larger roasting dish and use less liquid.
Steam rises from the roast when basted.	This is normal and due to the laws of physics. The majority of the steam escapes through the steam outlet. It may settle and form condensation on the cooler switch panel or on the fronts of adjacent units.

Slow cooking

Slow cooking, also known as low-temperature cooking, is the ideal cooking method for tender pieces of meat that are to be cooked medium rare or à point. Meat remains very succulent and tender.

The benefit of this cooking method is that it allows lots of scope for menu planning because slow-cooked meat is easy to keep warm.

Notes

- Only use fresh, good-quality meat. Carefully remove sinews and fat from around the edge. Fat develops a strong, distinct taste during slow cooking.
- Larger pieces of meat do not need to be turned.
- Meat can be carved immediately following slow cooking. No standing time is required.
- Due to the special cooking method, the meat looks pink, i.e. medium rare. This does not mean, however, that it is raw or not well done enough.
- If you want to make gravy, cook the meat in ovenware with a lid. Please note that the cooking times will be reduced.
- In order to check whether the meat is cooked, use a meat thermometer. A core temperature of 60 °C should be maintained for at least 30 minutes.

Suitable ovenware

Use shallow ovenware, e.g. a porcelain serving plate or an glass roasting dish without the lid.



Always place the uncovered ovenware on the wire rack at level 2.

Making settings

1. Select  Top/bottom heating and set a temperature between 70 and 90 °C.
Preheat the oven, placing the ovenware inside it to warm.
2. Rapidly heat a little fat in a pan. Sear the meat on all sides, even on the ends, and place immediately on the preheated ovenware.
3. Put the ovenware containing the meat back in the oven and slow cook. A slow-cook temperature of 80 °C is ideal for most pieces of meat.

Table

All tender joints of poultry, beef, veal, pork and lamb are suitable for slow cooking. The slow cooking times depend on the thickness and the core temperature of the meat.

Dish	Weight	Level	Type of heating	Temperature in °C	Searing time in minutes	Slow cooking time in hours
Poultry						
Turkey breast	1000 g	2		80	6-7	4-5
Duck breast*	300-400 g	2		80	3-5	2-2½

* For crispy skin, briefly fry the duck breast in a frying pan after slow cooking.

Dish	Weight	Level	Type of heating	Temperature in °C	Searing time in minutes	Slow cooking time in hours
Beef						
Joint of beef (e.g. rump) 6-7 cm thick	approx. 1.5 kg	2	☐	80	6-7	4½-5½
Tenderloin, whole	approx. 1.5 kg	2	☐	80	6-7	5-6
Sirloin, 5-6 cm thick	approx. 1.5 kg	2	☐	80	6-7	4-5
Steak-cut rump, 3 cm thick		2	☐	80	5-7	80-110 Min.
Veal						
Joint of veal (e.g. topside), 6-7 cm thick	approx. 1.5 kg	2	☐	80	6-7	5-6
Fillet of veal	approx. 800 g	2	☐	80	6-7	3-3½
Pork						
Pork joint, lean (e.g. loin), 5-6 cm thick	approx. 1.5 kg	2	☐	80	6-7	5-6
Fillet of pork, whole	approx. 500 g	2	☐	80	6-7	2½-3
Lamb						
Lamb saddle fillet, whole	approx. 200 g	2	☐	80	5-6	1½-2

* For crispy skin, briefly fry the duck breast in a frying pan after slow cooking.

Tips for slow cooking

Slow-cooked meat is not as hot as conventionally roasted meat. So that the roasted meat does not cool so quickly, warm the plates and serve the gravy very hot.

If you wish to keep slow-cooked meat warm. After slow cooking, turn the temperature down to 70 °C. Small pieces of meat can be kept warm for up to 45 minutes, larger pieces for up to 2 hours.

Bakes, gratins, toast with toppings

Always place ovenware on the wire rack.

If you are grilling directly on the wire rack without ovenware, you should also insert the universal pan at level 1. This keeps the oven cleaner.

How well cooked the bake is will depend on the size of the ovenware and the height of the bake. The figures in the table are only average values.

Dish	Accessories and ovenware	Level	Type of heating	Temperature in °C, grill setting	Cooking time in minutes
Bakes					
Bake, sweet	ovenproof dish	2	☐	180-200	50-60
Soufflé	ovenproof dish	2	☐	180-200	35-45
	Ramekins	2	☐	200-220	20-25
Pasta bake	ovenproof dish	2	☐	200-220	40-50
Lasagne	ovenproof dish	2	☐	180-200	40-50
Gratin					
Potato gratin, raw ingredients, max. 4 cm deep	1 ovenproof dish	2	☒	160-180	60-80
	2 ovenproof dishes	3+1	☒	150-170	60-80
Toast					
4 slices, with topping	wire rack + universal pan	3+1	☒	160-170	10-15
12 slices, with topping	wire rack + universal pan	3+1	☒	160-170	15-20

Convenience products

Observe the instructions on the packaging.

If you line the accessories with greaseproof paper, make sure that the paper is suitable for these temperatures. Make sure the paper is a suitable size for the dish to be cooked.

The cooking result greatly depends on the quality of the food. Pre-browning and irregularities can sometimes even be found on the raw product.

Dish	Accessories	Level	Type of heating	Temperature in °C	Cooking time in minutes
Pizza, frozen					
Pizza with thin base	universal pan	2	/	200-220	15-25
	universal pan + wire rack	3+1		180-200	20-30
Pizza with deep-pan base	universal pan	2	/	170-190	20-30
	universal pan + wire rack	3+1		170-190	25-35
Pizza baguette	universal pan	3	/	170-190	20-30
Mini pizza	universal pan	3	/	190-210	10-20
Pizza, chilled					
Pizza (preheat)	universal pan	1	/	180-200	10-15
Potato products, frozen					
Chips	universal pan	3	/	190-210	20-30
	universal pan + baking tray	3+1		180-200	30-40
Croquettes	universal pan	3	/	190-210	20-25
Rösti, stuffed potato pockets	universal pan	3	/	200-220	15-25
Baked items, frozen					
Bread rolls, baguette	universal pan	3	/	180-200	10-20
Pretzels (dough)	universal pan	3	/	200-220	10-20
Baked items, prebaked					
Part-cooked rolls, part-cooked baguette	universal pan	2		190-210	10-20
	universal pan + wire rack	3+1		160-180	20-25
Processed portions, frozen					
Fish fingers	universal pan	2	/	220-240	10-20
Chicken goujons, chicken nuggets	universal pan	3	/	200-220	15-25
Strudel, frozen					
Strudel	universal pan	3	/	190-210	30-35

Special dishes

At low temperatures, 3D hot air is equally useful for producing creamy yoghurt as it is for proving light yeast dough.

First, remove accessories, hook-in racks or telescopic shelves from the cooking compartment.

Preparing yoghurt

1. Bring 1 litre of milk (3.5 % fat) to the boil and cool down to 40 °C.
2. Stir in 150 g of yoghurt (at refrigerator temperature).
3. Pour into cups or small screw-top jars and cover with cling film.

4. Preheat the cooking compartment as indicated.

5. Place the cups or jars on the cooking compartment floor and incubate as indicated.

Proving dough

1. Prepare the dough as usual, place it in a heat-resistant ceramic dish and cover.
2. Preheat the cooking compartment as indicated.
3. Switch off the oven and place the dough in the cooking compartment and leave it to prove.

Dish	Ovenware		Type of heating	Temperature	Cooking time
Yoghurt	Cups or screw-top jars	on the cooking compartment floor		50 °C Preheat	5 mins
				50 °C	8 hrs
Proving dough	Heat-resistant dish	on the cooking compartment floor		50 °C Preheat	5-10 mins
				Switch off the appliance and place the yeast dough in the cooking compartment	20-30 mins

Defrost

This  Defrost setting is most ideal for frozen goods.



The defrosting time will depend on the type and quantity of the food.

Observe the instructions on the packaging.

Take frozen food out of its packaging and place in suitable ovenware on the wire rack.

Place poultry on a plate with the breast side facing down.

Note: The oven light does not come on at temperatures of less than 60 °C. This enables precise temperature regulation.

Dish	Accessories	Level	Type of heating	Temperature
Delicate frozen foods e.g. cream gateaux, buttercream cakes, gateaux with chocolate or sugar-based icing, fruit, etc.	wire rack	1		30 °C
Other frozen products Chicken, sausage and meat, bread and bread rolls, cake and other baked goods	wire rack	1		50 °C

Drying

With  3D hot air, you can dry foods brilliantly.





Use unblemished fruit and vegetables only and wash them thoroughly.

Drain off the excess water, then dry them.

Line the universal pan and the wire rack with greaseproof or parchment paper.

Turn very juicy fruit or vegetables several times.

Remove fruit and vegetables from the paper as soon as they have dried.

Fruit and herbs	Accessories	Level	Type of heating	Temperature	Cooking time
600 g apple rings	Universal pan + rack	3+1		80 °C	5 hrs (approx.)
800 g pear slices	Universal pan + rack	3+1		80 °C	8 hrs (approx.)
1.5 kg damsons or plums	Universal pan + rack	3+1		80 °C	8-10 hrs (approx.)
200 g herbs, washed	Universal pan + rack	3+1		80 °C	1½ hrs (approx.)

Preserving

For preserving, the jars and rubber seals must be clean and intact. If possible, use jars of the same size. The information in the table is for round, one-litre jars.

Caution!

Do not use jars that are larger or taller than this. The lids could crack.

Only use fruit and vegetables in good condition. Wash them thoroughly.

The times given in the tables are a guide only. The time will depend on the room temperature, number of jars, and the quantity and temperature of the contents. Before you switch off the appliance or change the cooking mode, check whether the contents of the jars are bubbling as they should.

Preparation

1. Fill the jars, but not to the top.
2. Wipe the rims of the jars, as they must be clean.
3. Place a damp rubber seal and a lid on each jar.
4. Seal the jars with the clips.

Place no more than six jars in the cooking compartment.

Making settings

1. Insert the universal pan at level 2. Arrange the jars on it so that they do not touch each other.
2. Pour ½ litre of hot water (approx. 80 °C) into the universal pan.
3. Close the oven door.
4. Set  Bottom heating.
5. Set the temperature to between 170 and 180 °C.
6. Start operation.

Preserving

Fruit

After approx. 40 to 50 minutes, small bubbles begin to form at short intervals. Switch off the oven.

After 25 to 35 minutes of residual heat, remove the preserving jars from the cooking compartment. If they are allowed to cool for longer in the cooking compartment, germs could multiply, promoting acidification of the preserved fruit.

Fruit in one-litre jars	When it starts to bubble	Residual heat
Apples, redcurrants, strawberries	Switch off	approx. 25 minutes
Cherries, apricots, peaches, gooseberries	Switch off	approx. 30 minutes
Apple purée, pears, plums	Switch off	approx. 35 minutes

Vegetables

As soon as bubbles begin to form in the jars, set the temperature back to between 120 and 140 °C. Depending on

the type of vegetable, heat for approx. 35 to 70 minutes. Switch off the oven after this time and use the residual heat.

Vegetables with cold cooking water in one-litre jars	When it starts to bubble	Residual heat
Gherkins	-	approx. 35 minutes
Beetroot	approx. 35 minutes	approx. 30 minutes
Brussels sprouts	approx. 45 minutes	approx. 30 minutes
Beans, kohlrabi, red cabbage	approx. 60 minutes	approx. 30 minutes
Peas	approx. 70 minutes	approx. 30 minutes

Taking out the jars

After preserving, remove the jars from the cooking compartment.

Caution!

Do not place the hot jars on a cold or wet surface. They could suddenly burst.

Acrylamide in foodstuffs

Acrylamide is mainly produced in grain and potato products prepared at high temperatures, such as potato crisps, chips,

toast, bread rolls, bread or fine baked goods (biscuits, gingerbread, cookies).

Tips for keeping acrylamide to a minimum when preparing food

General	
	<ul style="list-style-type: none">■ Keep cooking times to a minimum.■ Cook meals until they are golden brown, but not too dark.■ Large, thick pieces of food contain less acrylamide.
Baking	With top/bottom heating max. 200 °C. With 3D hot air or hot air max. 180 °C.
Biscuits	With top/bottom heating max. 190 °C. With 3D hot air or hot air max. 170 °C. Egg or egg yolk reduces the production of acrylamide.
Oven chips	Spread evenly over the baking tray, in a single layer. Bake at least 400 g per baking tray so that the chips do not dry out

Test dishes

These tables have been produced for test institutes to facilitate the inspection and testing of the various appliances.

In accordance with EN 50304/EN 60350 (2009) and IEC 60350.

Baking

Baking on 2 levels:

Always insert the universal pan above the baking tray.

Baking on 3 levels:

Insert the universal pan in the middle.

Viennese whirls:

Baking trays that are placed in the oven at the same time will not necessarily be ready at the same time.

Apple pie on 1 level:

Place dark springform cake tins next to each other diagonally on the same level.





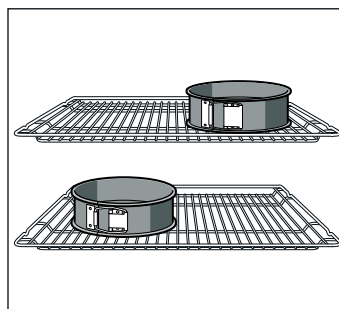







Apple pie on 2 levels:

Place dark springform cake tins next to each other (see illustration).



Cakes in tinplate springform cake tins:



Bake on 1 level with  Top/bottom heating Place the springform cake tin on the universal pan instead of on the wire rack.

Dish	Accessories and tins	Level	Type of heating	Temperature in °C	Cooking time in minutes
Viennese whirls (preheat*)	baking tray	3		140-150	30-40
	baking tray	3		140-150	25-35
	universal pan + baking tray	3+1		140-150	30-45
	2 baking trays + universal pan	5+3+1		130-140	35-50
Small cakes (preheat*)	baking tray	3		150-170	20-30
	baking tray	3		150-160	20-30
	universal pan + baking tray	3+1		140-160	25-40
	2 baking trays + universal pan	5+3+1		130-150	25-40
Hot water sponge cake (preheat*)	springform cake tin on the wire rack	2		160-170	30-40
Hot water sponge cake	springform cake tin on the wire rack	2		150-160	35-45
Apple pie	wire rack + 2 springform cake tins, dia. 20 cm	1		180-200	70-90
	2 wire racks + 2 springform cake tins, dia. 20 cm	3+1		170-190	70-80

* Do not use rapid heating to preheat the appliance.

Grilling

If you are grilling food directly on the wire rack, the universal pan should also be inserted at level 1. The liquid is then collected, keeping the oven cleaner.

Dish	Accessories	Level	Type of heating	Grill setting	Cooking time in minutes
Toast Preheat for 10 minutes	Wire rack	5		3	1/2-2
Beefburgers, 12 pieces* do not preheat	Wire rack + universal pan	4+1		3	25-30

* turn over after $\frac{2}{3}$ of the cooking time.

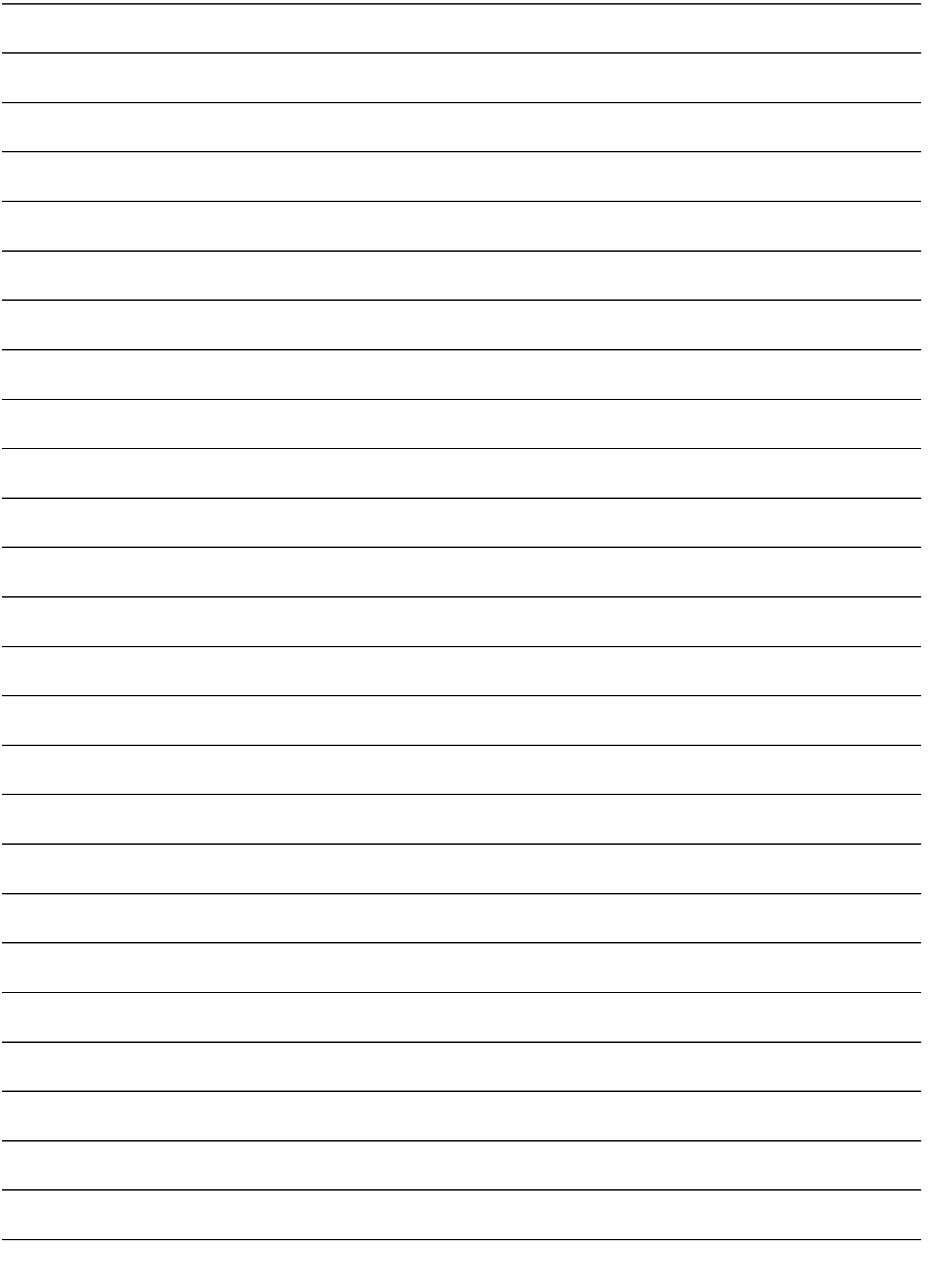



Robert Bosch Hausgeräte GmbH

Carl-Wery-Straße 34

81739 München

Germany

www.bosch-home.com



9000633948

910125